

NASA TP-1998-208920



Mir Mission Chronicle

November 1994 - August 1996

Sue McDonald

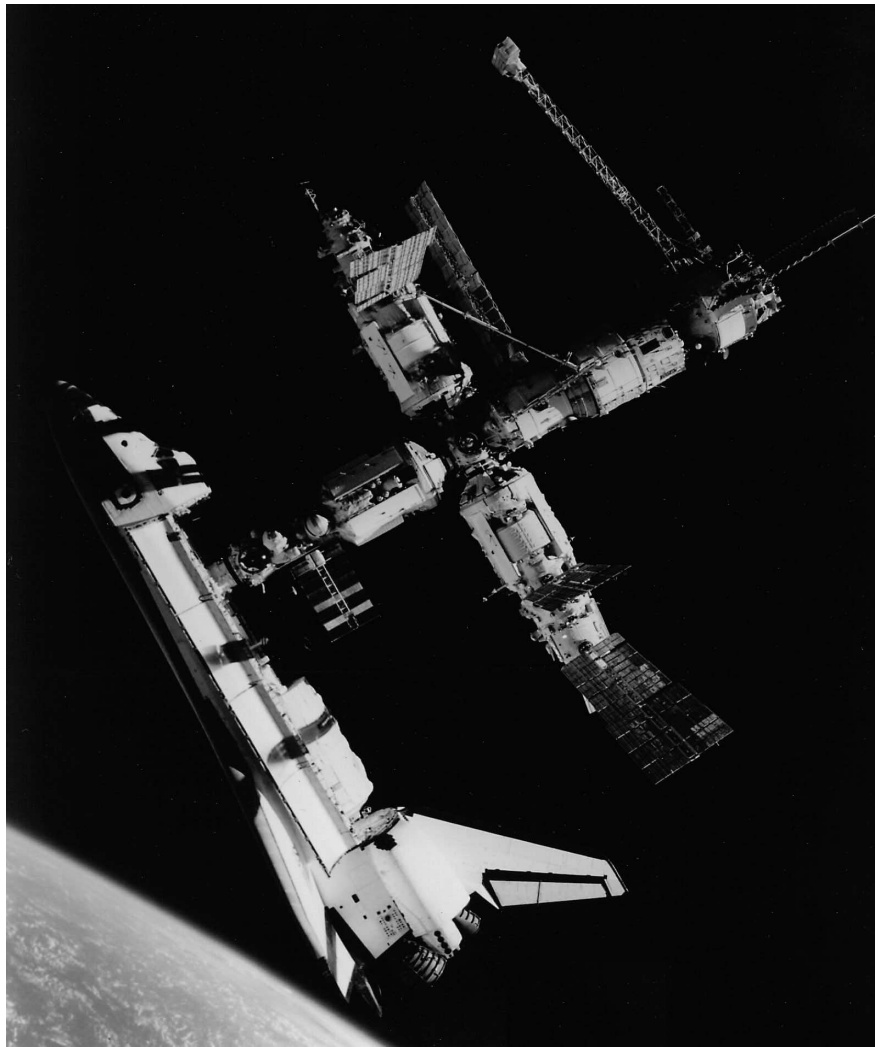

December 1998

The NASA STI Program Office . . . in Profile

Since its founding, NASA has been dedicated to the advancement of aeronautics and space science. The NASA Scientific and Technical Information (STI) Program Office plays a key part in helping NASA maintain this important role.

The NASA STI Program Office is operated by Langley Research Center, the lead center for NASA's scientific and technical information. The NASA STI Program Office provides access to the NASA STI Database, the largest collection of aeronautical and space science STI in the world. The Program Office is also NASA's institutional mechanism for disseminating the results of its research and development activities. These results are published by NASA in the NASA STI Report Series, which includes the following report types:

- **TECHNICAL PUBLICATION.** Reports of completed research or a major significant phase of research that present the results of NASA programs and include extensive data or theoretical analysis. Includes compilations of significant scientific and technical data and information deemed to be of continuing reference value. NASA's counterpart of peer-reviewed formal professional papers but has less stringent limitations on manuscript length and extent of graphic presentations.
- **TECHNICAL MEMORANDUM.** Scientific and technical findings that are preliminary or of specialized interest, e.g., quick release reports, working papers, and bibliographies that contain minimal annotation. Does not contain extensive analysis.
- **CONTRACTOR REPORT.** Scientific and technical findings by NASA-sponsored contractors and grantees.

- **CONFERENCE PUBLICATION.** Collected papers from scientific and technical conferences, symposia, seminars, or other meetings sponsored or cosponsored by NASA.
- **SPECIAL PUBLICATION.** Scientific, technical, or historical information from NASA programs, projects, and mission, often concerned with subjects having substantial public interest.
- **TECHNICAL TRANSLATION.** English-language translations of foreign scientific and technical material pertinent to NASA's mission.

Specialized services that complement the STI Program Office's diverse offerings include creating custom thesauri, building customized databases, organizing and publishing research results . . . even providing videos.

For more information about the NASA STI Program Office, see the following:

- Page at <http://www.sti.nasa.gov>
- E-mail your question via the Internet to help@sti.nasa.gov
- Fax your question to the NASA STI Help Desk at (301) 621-0134
- Telephone the NASA STI Help Desk at (301) 621-0390
- Write to:
NASA STI Help Desk
NASA Center for AeroSpace Information
7121 Standard Drive
Hanover, MD 21076-1320

NASA TP-1998-208920

Mir Mission Chronicle

November 1994 - August 1996

Sue McDonald
Lyndon B. Johnson Space Center

National Aeronautics and
Space Administration

Lyndon B. Johnson Space Center
Houston, Texas 77058-4406

December 1998

Acknowledgments

The concept of this document is based on David S. F. Portree's "Mir Hardware Heritage," published in 1995. Mr. Portree is currently working on his own followup to "Heritage," to be published after Mir deorbit. My thanks to Mr. Portree for serving as my consultant during the writing of this document and as its principal reviewer. Thanks also to Joseph P. Loftus, Jr., Nicholas L. Johnson, and Tom Sullivan for their reviews and comments. The icons and drawings herein, including the cover drawing, were prepared by Laurie Buchanan of the Johnson Space Center Graphics Services, who also prepared those for "Mir Hardware Heritage," with the advice of Mr. Portree.

Available from

NASA Center for Aerospace Information
7121 Standard
Hanover, MD 21076-1320

National Technical Information Service
5285 Port Royal Road
Springfield, VA 22161

Contents

	page
Acronyms	v
Introduction	1
Mir Principal Expedition 17	3
Mir Principal Expedition 18	9
Mir Principal Expedition 19	22
Mir Principal Expedition 20 and Euromir 95	26
Mir Principal Expedition 21	37
Appendix: Comparative Chronology of U.S./Russian Human Space Missions	51
References	57
Index	63

Boxes

STS-63 Mission Highlights	5
Spektr	14
Orbiter Docking System	18
STS-71 Mission Highlights	20
STS-74 Mission Highlights	30
Docking Module	30
STS-76 Mission Highlights	38
Priroda	42

Figures

1 Key to Icons	2
2 The Mir complex at the end of 1994	2
3 The Mir space station, photographed from Discovery	7
4a Spektr in July, 1995 [drawing]	15
4b Spektr after installation [photo]	15
5 Mir space station configuration on May 26, 1995	16
6 Orbiter Docking System mounted in the payload bay of Atlantis	18
7 First docking of Atlantis with the Mir complex, June 29, 1995	21
8 The Mir complex as configured on June 2, 1995	24
9a The Russian-designed Docking Module [drawing]	31
9b The Docking Module in Atlantis' payload bay [photo]	31
10 Mir with new Docking Module installed on Kristall	34
11 The Priroda module	43
12 The Mir complex on May 7, 1996, with all base block ports occupied	45

Acronyms

APAS	androgynous peripheral assembly system
APDA	androgynous peripheral docking assembly
APDS	androgynous peripheral docking system
CADMOS	[CNES mission control center]
CFM	Candle Flame in Microgravity
CNES	Centre National d'Etudes Spatiales
DM	Docking Module
EDLS	Enhanced Dynamic Load Sensors
ESA	European Space Agency
ESEF	European Space Exposure Facility
EVA	extravehicular activity
GSC	grab sample container
IMU	inertial measurement unit
MCSA	Mir Cooperative Solar Array
MEEP	Mir Environmental Effects Payload
MIM	Microgravity Isolation Mount
MIPS	Mir interface-to-payload systems
MIRAS	Mir Infrared Atmospheric Spectrometer
MOMS	Modular Optoelectronic Multispectral Scanner
NASA	National Aeronautics and Space Administration
NIVR	Dutch National Institute for Aerospace Programs
ODS	Orbiter Docking System
OLiPSE	Optizon Liquid Phase Sintering Experiment
OMS	orbital maneuvering system
OSVS	Orbiter space vision system
PASDE	Photogrammetric Appendage Structural Dynamics Experiment
PLSS	portable life support system
POSA	Anticipatory Postural Activity
QUELD	Queen's University Experiment in Liquid Diffusion
RCS	reaction control system
RMS	remote manipulator system
RSA	Russian Space Agency

SAFER	simplified aid for EVA rescue
SAMS	Space Acceleration Measurement System
SAR	synthetic aperture radar
SPK	Stredstvo Peredvizheniy Kosmonatov [cosmonaut maneuvering unit]
SSAS	Solid Sorbent Air Sampler
STS-	Space Transportation System [designation for U.S. Space shuttle missions]
TDRS	Tracking and Data Relay Satellite
TEPC	Tissue Equivalent Proportional Counter
TI	terminal [phase] initiation
TSuP	Tsentr Upravleniya Polyotami [Russian flight control center]

Introduction

This document chronicles dockings, module additions, configuration changes, and major events of Mir Principal Expeditions 17 through 21, November 1994 through August 1996. It provides a follow-up to David S. F. Portree's "Mir Hardware Heritage" (NASA RP-1357), which described the history of Soviet/Russian space stations, beginning with precursor space modules and continuing through the mid-November 1994 configuration of the Mir space station complex.

Although Mir has hosted international crews since its early days, increasing focus was placed on international cooperation beginning in 1995. In the period covered by this document, a series of joint missions with the United States began as part of International Space Station Phase I. The first was the rendezvous of the Space Shuttle Discovery with Mir in February 1995, followed in March by the first mission (Mir 18) in which a U.S. astronaut, Norm Thagard, launched on a Soyuz-TM vehicle and served as a Mir crew member. In June of the same year, during U.S. mission STS-71, the Space Shuttle Atlantis docked with Mir for the first time. It brought with it the Mir 19 crew of two and took the Mir 18 crew of three home to Earth; during this docking the ten members of the combined crews set a record for humans aboard a single space complex. Mir 20 hosted European Space Agency (ESA) astronaut Thomas Reiter for Euromir 95 and was visited by Atlantis again on mission STS-74. During Mir 21, Atlantis docked with Mir a third time (STS-76), bringing the second U.S. astronaut to serve as a Mir crew member, Shannon Lucid. In August, while Lucid was still aboard, Mir 21 hosted French cosmonaut-researcher Claudie Andre-Deshays and her Cassiopee scientific experiments.

The three new modules added to Mir during this period also reflected the trend of international cooperation:

- Spektr, a habitable science module added in May 1995, bore an international complement of instruments for Earth observation and sampling and analysis of Earth's atmosphere and the orbital environment.
- The Docking Module, built by Russia with U.S. cooperation, was added to Kristall during the November 1995 (STS-74) Atlantis docking to eliminate the need to move Kristall to the -X port each time Atlantis docked with the station.
- Priroda, the last permanent habitable module, with experiments designed by 12 nations to gather data on the Earth and its atmosphere, was added in April 1996.

In addition to the three Atlantis dockings and the initial dockings of Priroda and Spektr, seven Progress-M and four Soyuz-TM dockings occurred between November 1994 and August 1996. Soyuz-TM 20, Soyuz-TM 21, and Progress-M 32 were each undocked and redocked once. Six relocations of Kristall, Spektr, and Priroda brought the total number of dockings for the period to 23. Using the icon concept developed for "Mir Hardware Heritage," each configuration is depicted at the left of the narrative description of mission events. A key to the individual icons is given in figure 1.

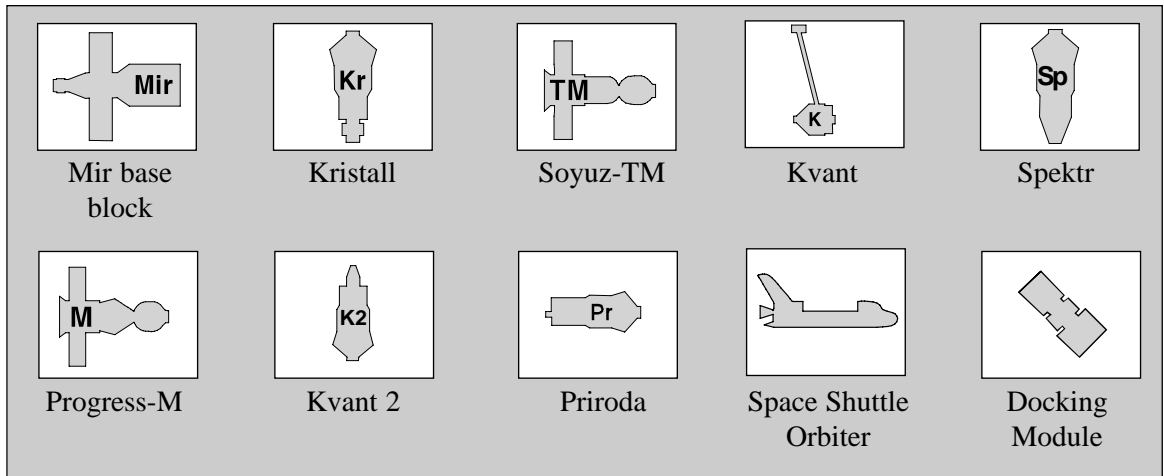

Figure 1. Key to Icons

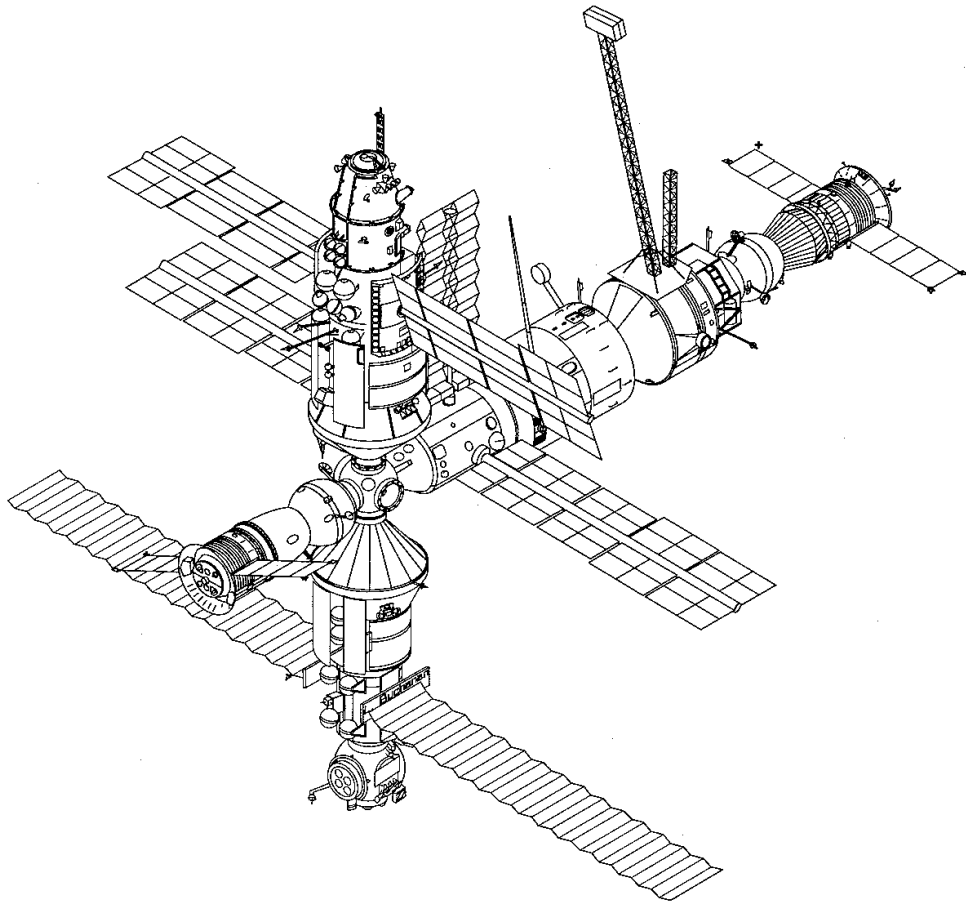

Figure 2. The Mir complex at the end of 1994. Shown left to right are Soyuz-TM 20, the Mir base block, Kvant, and Progress-M 25. Shown vertically, top to bottom, are Kvant 2 and Kristall. This was still the station's configuration at the time of the Space Shuttle Discovery rendezvous on February 6, 1995.

Mir Principal Expedition 17

Commander Alexandr Viktorenko
 Flight Engineer Yelena Kondakova
 Cosmonaut Researcher Valeri Polyakov
 Crew code name: Vityaz
 Launched and landed in Soyuz-TM 20,
 October 3, 1994 - March 22, 1995
 169 days in space

Highlights: Mir 17 hosted the first ESA mission aboard Mir, Euromir 94, which ended November 4. Another international milestone was the rendezvous of the Space Shuttle Atlantis on its mission STS-63 with Mir. A new human spaceflight duration record was established by Polyakov with his 438-day stay on the station.

Background: In mid-November of 1994 (at the close of D.S.F. Portree's "Mir Hardware Heritage"), the Mir space station complex, shown in figure 2, included these modules:

- The Kvant astrophysics module (added April 9, 1987)
- The Kvant 2 augmentation module (added December 6, 1989)
- The Kristall technology module (added June 10, 1990)
- Soyuz-TM 20, which on October 6, 1994, had delivered two members of the Mir Principal Expedition 17 crew, Commander Alexandr Viktorenko and Flight Engineer Yelena Kondakova, and Euromir 94 astronaut Ulf Merbold. They joined Valeri Polyakov, a station resident since the beginning of Principal Expedition 15 in January 1994.
- Progress-M 25, a cargo resupply ship which had docked with the complex on November 13, 1994, to deliver water, fuel, food, and materials for repairs, including parts for the CSK-1 materials processing furnace.

**November 13, 1994 -
 February 6, 1995**

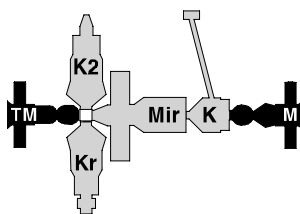

**Kvant 2
 Soyuz-TM 20 - Mir - Kvant - Progress-M 25
 Kristall**

November activities. After completion of the Euromir 94 experiment program and departure of ESA astronaut Ulf Merbold on November 4, the cosmonauts continued with medical and health studies. Progress-M 25 arrived on the 13th. The crew unloaded its cargo, then installed new equipment and oversaw the refueling of the base block tanks. The base block completed its 50,000th Earth orbit on November 18.

A busy end to 1994. Throughout December, the crew's work included physiological, medical, and astrophysical studies, as well as measurement of noise intensity in the station's habitable areas. Using the French Nausica apparatus, they measured radiation levels in low Earth orbit. They took data on micrometeorite fluxes along the velocity vector of the station as part of an experiment to determine the effects of the orbital environment on materials and equipment mounted on the exterior of the complex.¹

**November 13, 1994 -
February 6, 1995**

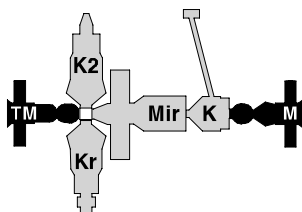

Continued

New communications relay satellite. The Luch-1 geostationary satellite was launched from Baikonur on December 16, 1994, as an additional relay station for Mir and TsUP communications, to become operational in 1995.

Experiments continue as new year in space begins. The Mir 17 crew continued astrophysical experiments using the Roentgen Observatory and Maria-2 equipment, technological research using the Gallar furnace, and biotechnical research using the Maksat experiments to study the effect of spaceflight on various biological cultures.²

Polyakov breaks spaceflight record. On January 9, Polyakov had been aboard the station 366 consecutive days, surpassing the 365-day record set by Vladimir Titov and Musa Manarov on Mir from December 21, 1987, through December 21, 1988.³ Adding his previous 242-day Mir mission, Polyakov now had the distinction of having spent more time in space than any other person—a total of 607 days.

Test of Kurs automatic docking system. The crew entered Soyuz-TM 20 on January 11 to conduct a test of the Kurs docking system. During its docking on October 6, the Soyuz vehicle began to yaw during final approach to the forward port, necessitating a manual docking. Progress-M 24 had also experienced docking problems at this port in August.⁴ To analyze reasons for these anomalies, Viktorenko undocked the Soyuz and moved away from the station to a distance of 160 m. The Kurs was then activated, and the Soyuz was guided to a successful redocking within 26 min of the undocking. Results of the tests showed that system deviations during approach were only 0.5°, considered within acceptable limits.⁵

Habitability problems. With instructions from the Russian Mission Control Center, (TsUP), the crew worked on technical problems with the heating system, drinking water, pressure control, and a water leak in the Kristall module. On January 23, Viktorenko adjusted the station's attitude so that the Kristall solar panels could deliver maximum energy for onboard power. In addition, the crew took images of the earthquake site in Kobe, Japan.⁶

Discovery launch. Originally scheduled for February 2, the STS-63 launch was delayed by a failure in inertial measurement unit (IMU) #2. Although the Orbiter can fly with only one of its three IMUs operational, the failed unit was replaced and launch was rescheduled for 24 hr later. On February 3, at 12:22 a.m. EST, Discovery was successfully launched with its crew of six, including cosmonaut Titov. Nine hr later, at an altitude of 190 nmi, Commander Wetherbee placed Discovery on an intercept course with Mir, some 7000 nmi behind the station.⁷

**November 13, 1994 -
February 6, 1995**

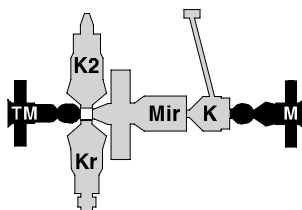

Concluded

Discovery thruster problems. Two reaction control system (RCS) thruster problems occurred during launch: the failure of L2D and a leak in R1U. The redundancy of Orbiter thruster systems and the tendency of leaks to clear once thrusters are warmed up seemed assurances of Discovery's ability to comply with the flight rule that all its aft thrusters must be operational before it moves within 300 m of Mir. However, the slow R1U leak persisted despite the positioning of Discovery so that the sun would warm the leaking jet. Then on February 4 another leak was detected, this time in forward RCS thruster F1F.⁸

STS-63 Mission Highlights

February 3-10, 1995

Commander James D. Wetherbee

Pilot Eileen M. Collins

Pilot Michael Foale

Mission Specialist Janice E. Voss

Mission Specialist Bernard A. Harris, Jr.

Cosmonaut Vladimir Titov

STS-63 was the first of the series of joint U.S.-Russian missions planned as part of Phase I of the International Space Station. The primary STS-63 mission objective was to rendezvous with and fly around Mir at a distance of 10 m to verify flight techniques, communications, and navigation aid sensor interfaces in preparation for the STS-71 docking of Atlantis with Mir in May. Also, NASA cooperated with the Russian Institute for Biomedical Problems to study radiobiological effects and sensory motor performance.⁹ In keeping with the theme of cooperation, Russian cosmonaut Vladimir Titov was aboard as a member of the STS-63 crew. Titov was the second cosmonaut to fly with an STS crew. Sergei Krikalev had flown on Discovery, launched exactly a year before for STS-60.¹⁰ For the STS-63 mission, Discovery, on its 20th flight, carried nine payloads, among them the Spacehab module with its 20 assorted experiments and the Spartan-204 free-flying retrievable astronomy platform.

Flight team cooperation. The concern of both U.S. and Russian ground control about the leaks inspired close cooperation between the two teams. By February 5 the Discovery crew had stopped the F1F leak by allowing pressure to build up in the manifold and then commanding the thruster to fire, thus clearing out residual fuel in the thruster. However, the same procedure did not work on the R1U thruster. As Discovery continued to draw closer to Mir, the two ground control teams reached an

agreement on proceeding with the rendezvous despite the leak. In the agreement, the right RCS manifold providing fuel to R1U would be closed before Discovery came within 300 m (984 ft) of Mir; the crew would back out to 122 m (400 ft) and hold position if any further RCS thruster capability was lost; and Discovery would go no closer to Mir than 10 m (32.8 ft) in any event.^{11,12} Vladimir A. Solovyov, director of TsUP, later said that the historic Mir/Discovery rendezvous showed both nations that “The realities of the Shuttle-Mir program are more complicated than we had thought.”¹³

February 6-8, 1995

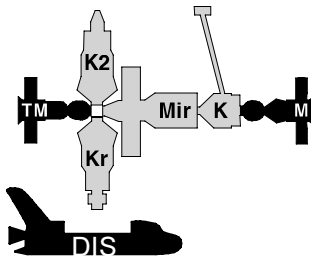

Kvant 2
Soyuz-TM 20 - Mir - Kvant - Progress-M 25
Kristall

Discovery

Rendezvous at last. As Discovery’s crew began their early morning preparations for the rendezvous, two flight options were still being considered: one would put Discovery about 10 m (32.8 ft) from Mir at its closest point; in the other, it would approach no closer than 122 m (400 ft). Between 8 a.m. and 9 a.m. EST, the crew fired Discovery’s engines twice to decrease the rate at which the Orbiter was overtaking Mir. By 12:59 p.m. EST, when Discovery was about 518 m (1700 ft) from Mir, the Mir crew could see Wetherbee waving from his window. At 1:22 p.m. EST, Discovery matched the velocity vector of Mir and linked up orbits at 128 m (422 ft). During the hour that it stayed in this position, the crews downlinked video of each other. Vladimir Titov used a handset for ham radio communications with his countrymen.¹⁴

Closest approach. At 2:23 p.m. EST, over the Pacific Ocean at an altitude of 213 nmi, Wetherbee and pilot Eileen Collins brought Discovery within 11 m (36 ft) of Mir, where it remained stable for 10 min in a position opposite the docking port of Kristall. Wetherbee said, “As we bring our ships closer together, we bring our nations closer together.” Viktorenko congratulated Wetherbee on a flawless approach.¹⁵

Discovery fly-around. After the close encounter, Discovery backed out to 400 ft and began fly-around operations. “It was like dancing in the cosmos,” reported Wetherbee. He and his crew collected data for the May docking of Atlantis with the station and took more than 400 photographs of Mir to be used in orbital debris effects studies.¹⁶ Figure 3 is a view of the station from Discovery.

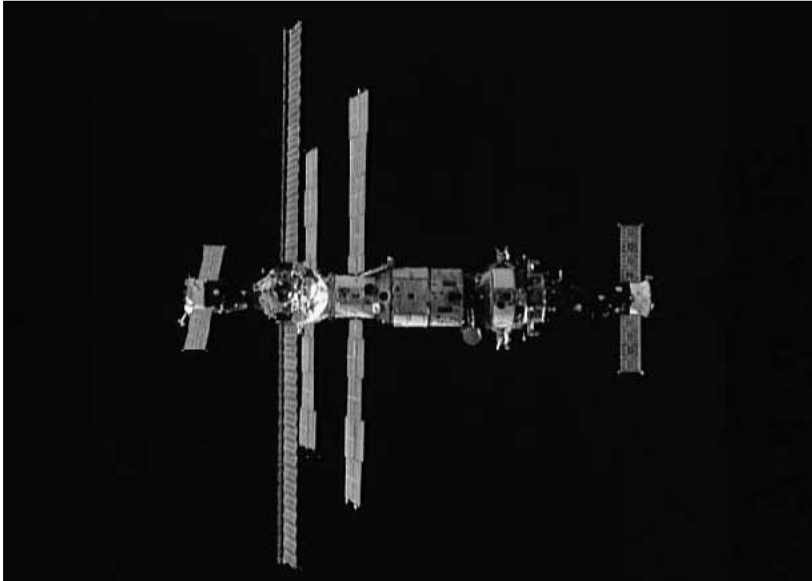

Figure 3. The Mir space station, photographed from the Space Shuttle Discovery during February 6, 1995, rendezvous operations.

February 8-16, 1995

Kvant 2

Soyuz-TM 20 - Mir - Kvant - Progress-M 25

Kristall

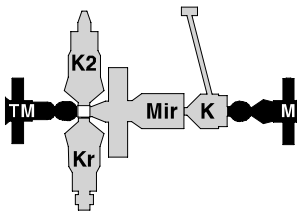

Rendezvous complete. At 4:13 p.m. EST on February 8, Discovery initiated a burn to depart to its own orbit (214 nmi x 207 nmi), where it was by 6:23 p.m. EST. According to Viktorenko, Discovery's thruster firings had not affected Mir's solar arrays.¹⁷ The two crews resumed their separate tasks, which for Discovery included release of the Spartan 204 satellite and an EVA by astronauts Bernard Harris and Michael Foale in which Harris manually manipulated the satellite to gain experience with handling of large objects in space.¹⁸ On the Mir complex, Polyakov trained at the controls of Soyuz-TM 20 as part of emergency preparedness. He also spoke with the astronauts by radio, congratulating them on their successful EVA.¹⁹

STS-63 mission ends. About 850 nmi from Discovery, Mir performed an on-orbit maneuver on February 10 that enabled the Orbiter crew to see the station like a small flashing star near the horizon. At 6:51 a.m. EST, Discovery touched down at Kennedy Space Center, completing its 20th flight.

Progress-M 26 launch. On February 15, Progress-M 26 was launched from Baikonur with a large cargo of supplies for the station and its occupants: water, food, oxygen, medical goods, fuel, oxidizers, and materials for repair of onboard systems. It also carried hardware and software for experiments by American astronaut Norm Thagard during his upcoming stint on Mir.²⁰

February 16-17, 1995

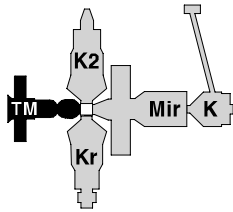

**Kvant 2
Soyuz-TM 20 - Mir - Kvant
Kristall**

Progress-M 25 undocks. To make room for its successor, Progress-M 25 left the Kvant docking port on February 16 for a destructive reentry over the Pacific, east of New Zealand.

**February 17 -
March 15, 1995**

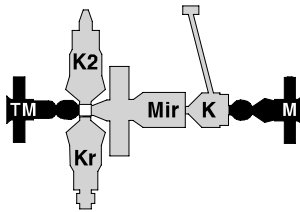

**Kvant 2
Soyuz-TM 20 - Mir - Kvant - Progress-M 26
Kristall**

No docking problems for this Progress-M. On February 17, Progress-M 26 docked successfully under control of the Kurs system. The crew had to remove obstructing cargo before they could enter the module and begin unloading the supplies.²¹

Ninth anniversary of Mir launch. The Mir 17 crew celebrated the ninth anniversary of the Mir base block launch on February 19. Throughout the remainder of the month and the early part of March, they continued with astrophysics experiments. They also prepared for their departure from Mir and the arrival of the Mir Principal Expedition 18 crew.²²

Mir Principal Expedition 18

Commander Vladimir Dezhurov (1st flight)
 Flight engineer Gennadiy Strekalov (5th)
 Cosmonaut-Researcher Norman Thagard
 (U.S. astronaut) (5th)
 Code name Uragan
 Launched in Soyuz-TM 21, March 14, 1995
 Landed in Space Shuttle Orbiter Atlantis,
 July 7, 1995
 115 days in space

Highlights: The major objectives of the Mir 18 mission were to conduct joint U.S.-Russian medical research and weightlessness effects investigations and to reconfigure the station for the arrival of the Spektr science module and the Space Shuttle Atlantis. The historic mission saw the addition of the first new module (Spektr) since Kristall arrived in 1990, the first American (Thagard) to be part of a Mir crew, and the first docking of a U.S. spacecraft with the Mir complex.

Soyuz-TM 21 launches new crew. On March 14, Soyuz-TM 21 launched from Baikonur with Dezhurov, Strekalov, and Thagard set to relieve the Mir 17 crew. Three hours after launch, the cosmonauts began a series of maneuvering burns to bring Soyuz-TM 21 to a rendezvous orbit. During the 2-day trip, they checked systems and collected biomedical data on the effects of microgravity on the human body.²³

Record number of humans in orbit. The launch of the Mir 18 crew brought to thirteen the number of men and women in space at the same time. This new record included the Mir 17 and 18 crews of three each and the STS-67 crew of seven aboard the Space Shuttle Endeavour, launched March 2. (Endeavour landed at Edwards Air force Base on March 18, surpassing previous Space Shuttle mission durations with its 16 days, 15 hr, and 08 min in space.)

March 15-16, 1995

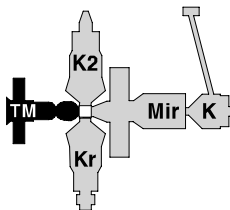

Kvant 2
Soyuz-TM 20 - Mir - Kvant
Kristall

Progress-M 26 clears Kvant docking port for new Soyuz-TM. Progress-M 26 separated from the complex on March 15 and made a destructive reentry into the Earth's atmosphere.

March 16-22, 1995

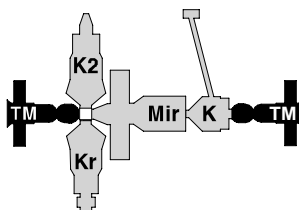

Kvant 2
Soyuz-TM 20 - Mir - Kvant - Soyuz-TM 21
Kristall

New Soyuz-TM 21 docks. Soyuz-TM 21 docked by automatic control at the Kvant docking port on the first try at 0745 UTC March 16.²⁴ The new arrivals were greeted by the Mir 17 crew with traditional Russian gifts of salt and bread, and shortly thereafter were congratulated on a successful docking and transfer by Russian Space Agency (RSA) Director General Yuri Koptev and NASA Associate Administrator Wayne Littles. The crew spent much of the day transferring equipment and supplies from Soyuz to Mir. Thagard spoke with STS-67 Commander Steve Oswald in a radio hookup, exchanging congratulations on their respective

March 16-22, 1995

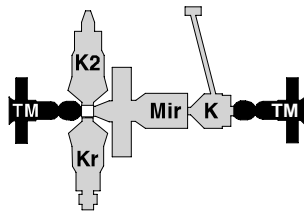

Concluded

flights and discussing the symbolic importance of Thagard's venture as the first American to visit Mir.²⁵

More congratulations. On March 17, Russian Prime Minister Viktor Chernomyrdin stopped by the TsUP to congratulate the crew. Later, in a televised communication with ground controllers, Thagard said he hoped his visit to Mir would be the start of long-term space cooperation between the two nations. He and Polyakov agreed that the present joint research might be the foundation for ultimate joint flights to Mars.²⁶

Joint crew occupancy. During the next few days, the Mir 18 crew took their body mass measurements as a baseline for investigations throughout the mission and were briefed by the Mir 17 crew on the status of the complex and ongoing studies. The outgoing crew stowed equipment and experiment samples in Soyuz-TM 20 for their return and checked out the vehicle systems.²⁷

**March 22, 1995 -
April 11, 1995**

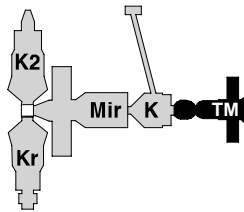

**Kvant 2
Mir - Kvant - Soyuz-TM 21
Kristall**

Mir 17 mission ends. Viktorenko, Kondakova, and Polyakov entered Soyuz-TM 20 on March 21 and departed from Mir on March 22, landing safely on the same day about 50 km from Arkalyk, Kazakhstan. Polyakov had set a new record for space-flight duration: he had been on Mir since January 8, 1994—for 438 straight days. This trip, added to his Mir stay in 1988, brought his total days in space to 679. He was, however, strong enough to walk to the chairs that rescue crews provided for the cosmonauts' transport to a field hospital. He said his fit condition was a positive indication that humans could withstand a trip to Mars.²⁸

Mir 18 crew on their own. The Mir 18 crew settled into their daily routine, collecting body fluid samples for the seven metabolic experiments to be performed during their mission. They also took air and water samples for four hygiene, sanitation, and radiation experiments which would determine the role of the Mir environment in human health, safety, and efficiency.²⁹ Each crewman spent time in the Chibis suit for measurement of cardiovascular system responses to lower body negative pressure. In the absence of gravity, blood pools in the upper torso and head, causing cardiovascular deconditioning. The Chibis suit seals at the waist and incrementally induces a partial vacuum, or negative pressure, which draws body fluids back to the lower extremities. Dezhurov and Strekalov also changed out a condenser in the air conditioning system, part of a long-term maintenance program to prolong the life of the station.³⁰

April 11 - May 22, 1995

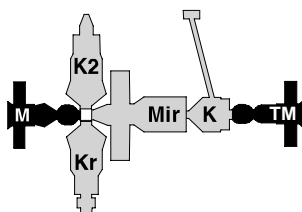

Kvant 2

Progress-M 27 - Mir - Kvant - Soyuz-TM 21

Kristall

Progress-M 27 goes to Mir. Progress-M 27 was launched from Baikonur on April 9. It docked with the Mir base block on April 11 at 21:00 UTC under flawless control by the automatic Kurs system, although Dezhurov was ready to take over by manual control if Kurs malfunctions recurred.³¹ This Progress module carried with it a Raduga return capsule.

Cosmonautics day observed on April 12. On the 34th anniversary of Yuri Gagarin's flight in a Vostok capsule, the Mir crew had a light schedule for Cosmonautics Day, a Russian national holiday. Activities included press conferences through the Russian and U.S. mission control centers.³²

Progress cargo unloaded. On April 13, the crew began unloading the Progress cargo of food, water, fuel, repair materials for life support systems, and equipment for medical and environmental research. Among the biological experiments were some Japanese quail eggs. These, the crew put into an incubator on April 14.³³

GFZ-1 microsatellite launched from Mir. Progress-M 27 also brought a new international experiment in the form of GFZ-1, a spherical satellite with a mass of 20 kg and a diameter of 21 cm. The German satellite was built by the German firm Kayser-Threde. Geoforschungszentrum Potsdam would coordinate the satellite's transmission of geodetic measurements by means of laser reflection to about 25 observatories around the globe. GFZ-1 was successfully launched by the Mir crew from the base block airlock on April 19. (Two days before, the crew had launched a container with garbage as a practice run for the operation.)³⁴

Interior station work. Late in April, the crew learned that extravehicular activities (EVAs) for solar array work, scheduled to start on April 28, had been postponed due to a delay in launch of the Spektr module. (One reason for the delay was that equipment to interface with Mir's manual control system was added to Spektr in case the Kurs system failed again.)³⁵ The crew continued routine experiment work, defrosted the ESA freezer, replaced a humidity control fan with one from Progress-M 27, installed a battery unit in the Kristall module, and began removing an unused shower in the Kvant module to make room for a new set of gyrodynes to support the upcoming Atlantis docking. They dismantled the shower and cut it into small pieces for stowage on the Progress module, then installed the gyrodynes.³⁶

Injury jeopardizes EVA plans. ITAR-TASS reported on May 5 that Strekalov had scratched his hand earlier during cleaning tasks. The scratch became inflamed and caused some concern about Strekalov's ability to do the EVA work. Medical specialists on the ground viewed downlink video of the hand and prescribed

April 11 - May 22, 1995

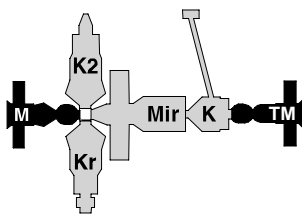

Concluded

a medication to be administered by Thagard. The injury healed and EVA plans proceeded.³⁷

EVA preparations. In the first week of May, the cosmonauts began preparing their EVA equipment and Orlan-DMA suits, taking inventory of connectors and cables needed for the EVA, and checking out communications systems. They installed power cables between Kvant and Kristall for transmission of power from the solar array that they would move from Kristall to Kvant on their second space walk. The Kristall batteries would be left in that module and would receive solar power through the new cables.³⁸

First Mir 18 EVA. On May 12, Dezhurov and Strekalov began their first EVA to prepare the station for Spektr's arrival, exiting the Kvant 2 airlock at 4:20 UTC and transferring to the Kvant astrophysics module by means of the Strela boom. There they installed electrical cable attachments and adjusted solar array actuators. Then they moved to Kristall and practiced folding three panels of the solar array to be moved to Kvant. Thagard supported the crew from inside Mir by relaying instructions from the ground or from reference manuals when the station was not in range of ground communications.³⁹ Lasting 6 hr and 15 min, the excursion had already exceeded the allotted time, so a third scheduled task, removal of American experiment TREK's space radiation detectors, had to be postponed until the next space walk.⁴⁰

Problems on second EVA. In their second space walk, on May 17, the cosmonauts successfully folded the solar array panels, assisted by Thagard, who controlled servomotor switches from inside Kristall. The spacewalkers disconnected the array from Kristall, attached it to the Strela boom, and moved it to Kvant. The work took so much time that, having already almost used the oxygen available through their suits, they were forced to secure the array to Kvant with tool tethers and postpone electrical connection. Even so, the EVA lasted 6 hr and 52 min.^{41,42} Power supply inside the station suffered without the connection of the array, necessitating interim augmentation by Progress-M 27 and Soyuz-TM 21 solar arrays.⁴³

Spektr launch. The Spektr science module was launched from Baikonur atop a Proton-K rocket at 3:33 UTC on May 20. The initial orbit was 337 by 221 km, period 89.8 min. In the 13 days until the docking of Spektr, the crew would be busy reconfiguring the complete to accommodate the new module.

Solar array redeployed in Mir 18 third EVA. On their May 22 walk of 5 hr, 15 min, Dezhurov and Strekalov successfully connected the solar array to Kvant, and Thagard commanded its redeployment from inside the station. The cosmonauts then returned to Kristall, where they retracted 13 panels of another solar array to provide clearance for rotation of Kristall during its relocation to make room for Spektr. Approximately 60% of that array was still available as a power source.⁴⁴

May 22-26, 1995

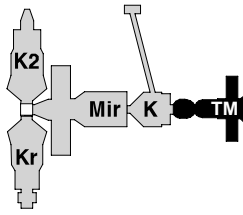

Kvant 2

Mir - Kvant - Soyuz-TM 21

Kristall

Progress-M 27 frees -X port. Progress-M 27 left Mir at 23:42 UTC on May 22 and made a destructive reentry into the Pacific on May 23. Thus the -Y port was freed for use in the multiple module relocation that would be necessary for the docking and ultimate permanent placement of Spektr.

Preparation for Kristall shifts. The crew began moving umbilicals, cables, and control panels for space suit servicing from Kvant 2 to the base block transfer compartment, which would be depressurized and used as the airlock for the next two EVAs.⁴⁵

May 26-30, 1995

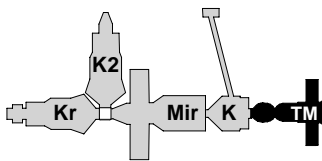

Kvant 2

Kristall - Mir - Kvant - Soyuz-TM 21

First Kristall move and fourth EVA. From inside the station, Dezhurov controlled the undocking of Kristall on May 26 from the -Y port (lower lateral port of the base block). Then the module was moved by means of its Lyappa arm to the -X port just vacated by Progress-M 27. Figure 5 shows the configuration on May 26 after the Kristall move. On May 28, in their fourth EVA of the mission, Dezhurov and Strekalov moved a docking cone (Konus), from the -X port to the -Z port to serve as the docking receptacle for Kristall in its next move. The space-suited cosmonauts did this work from inside the depressurized base block transfer compartment.^{46,47}

May 30 - June 1, 1995

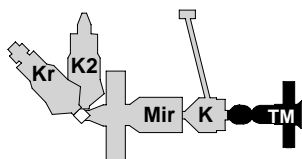

Kristall Kvant 2

- Mir - Kvant - Soyuz-TM 21

Second Kristall move. In another undocking and relocation sequence controlled from inside the station, on May 30 Kristall was moved from the -X port to the -Z port. Because of a temporary failure in hydraulic connections, the docking was not successful until the third attempt.⁴⁸

Spektr

Specifications

mass-19640 kg

length-14.4 m

maximum diameter-4.35 m

pressurized vol-61.9 m³

solar array area-132 m²

power output-6.9 kW

Description

The Spektr science module (fig. 4), designed by RKK Energia and built by the Khrunichev factory in Moscow, was the first new permanent module to join the Mir complex since Kristall was added in June 1990.⁴⁹ It was originally intended for addition to the complex in the 1990-1992 time frame.⁵⁰

The module was equipped with orbit correction and rendezvous engines and attitude control and docking thrusters. A Kurs guidance system provided automatic rendezvous and docking guidance. Like all other Mir modules, Spektr has a Lyappa manipulator arm for repositioning the module to other ports after initial docking.

The original module design included two solar panels, but after Mir's power problems became acute, the design was changed to incorporate four solar panels. The pair on the pressurized compartment supplies power for the module's own systems; the V-shaped pair on the unpressurized compartment were added to supplement power to the station complex.

Spektr has an unpressurized compartment (5.6 m long), primarily for autonomous Earth sensors, and a pressurized compartment (8.8 m long) which provides 61.9 m³ of work area. This pressurized area provides experiment accommodations such as electrical connectors, power supply switching units, thermoelectric installation sites, workstations and tables, Velcro pads, and cargo containers. Other items to support the crew as they work in the module are a low-noise headset, a clock, a loudspeaker, and a jet foam fire extinguisher.

Most of the Russian and international experiments and sensors aboard are for Earth observation, orbital environment sampling, and Earth atmosphere analysis. These include

- Astra-2 for atmospheric trace constituent monitoring
- Faza spectrometer for Earth surface studies
- Feniks infrared spectrometer for Earth surface studies
- Grif equipment for studying electromagnetic radiation and charged particle flows
- Komza interstellar gas detector (Swiss)
- Lira instrument complex for atmospheric research
- Mir Infrared Atmospheric Spectrometer (MIRAS) for studying interactions between solar radiation and the Earth's atmosphere, to be deployed on the exterior of the module during an EVA (Belgian-French)
- Pion optical complex for atmospheric research
- Priroda-5 Earth imaging system
- Ryabina-4P cosmic ray sensor

- Taurus system for studying electromagnetic radiation and charged particle flows
- European Space Exposure Facility (ESEF) for sensors that would be installed on the exterior of the module during a Euromir 95 EVA. Until installation, the mounting sites had covers that themselves contained instruments to monitor radiation in the orbital environment.

U.S. equipment aboard was largely for biomedical experiments that would be conducted on Mir 18 by Norm Thagard and on future missions by other American astronauts.^{51,52,53,54,55,56}

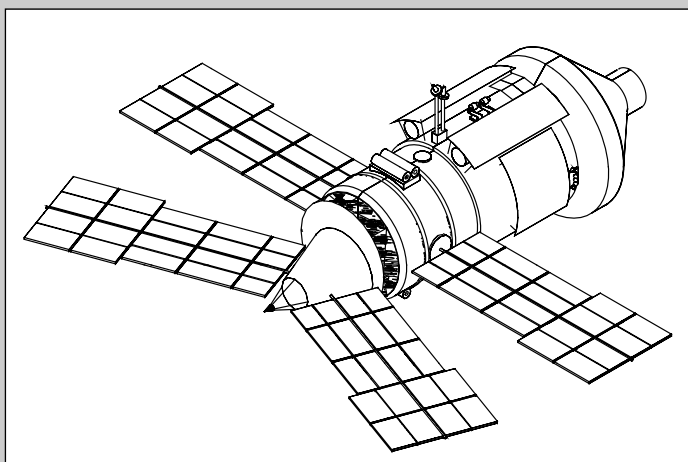

Figure 4a. Spektr, the science module that was added to Mir in May 1995. The module is shown here with solar arrays deployed, a configuration finally achieved on July 14, 1995.

Figure 4b. Spektr after installation. Clouds over Brazil form the backdrop for this 70mm image of the module and other Mir components taken from Atlantis while docked with Mir on March 23, 1996.



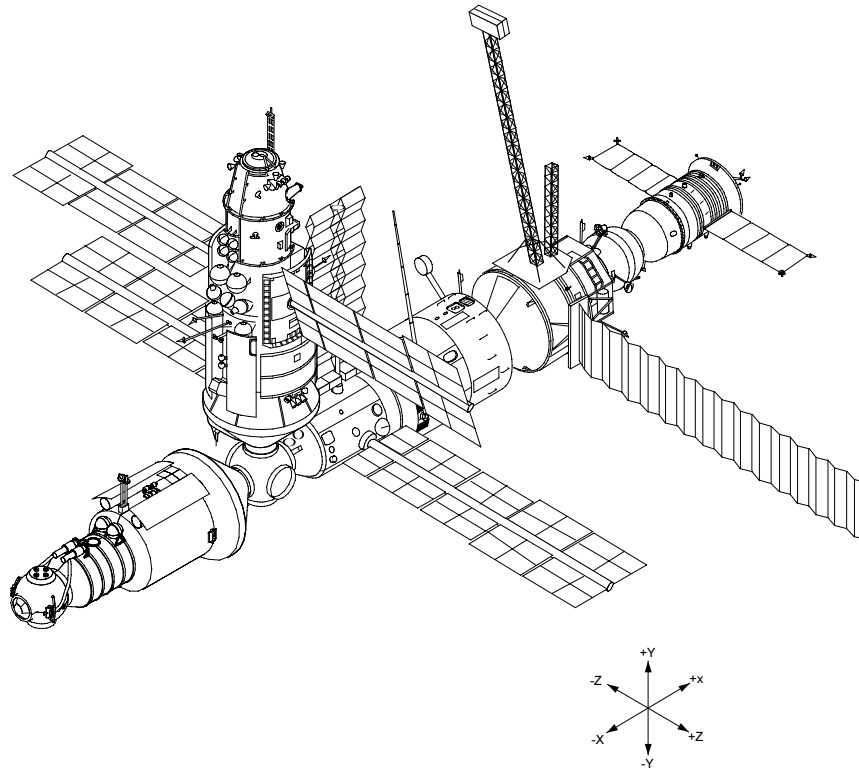
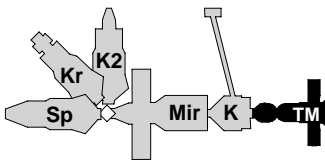

Figure 5. Mir space station configuration on May 26, 1995, after Kristall relocation to the -X port. Kristall is shown without solar arrays, one having been moved to Kvant on May 17, the other retracted on May 22 to provide clearance for Kristall relocation. Port orientations are diagrammed at lower right.

June 1-2, 1995

**Kristall Kvant 2
Spektr - Mir - Kvant - Soyuz-TM 21**



Spektr docking and fifth EVA. Despite anxieties about the automatic docking, the Spektr module successfully docked to the -X port under control of the Kurs system on June 1. The next day, in their fifth EVA, the cosmonauts again entered the depressurized base block transfer compartment and moved the Konus from the -Z to the -Y port.⁵⁷

June 2-10, 1995

**Kristall Kvant 2
- Mir - Kvant - Soyuz-TM 21
Spektr**

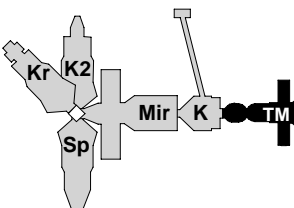

Spektr relocated. With the Mir crew and TsUP ground controllers in joint control of the Spektr Lyappa arm, the module was moved to the -Y port on June 2.

June 2-10, 1995

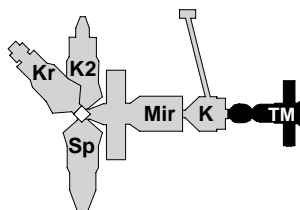

Concluded

Spektr solar array fails to extend fully. After the redocking, the crew began checking out and activating the new module's systems and transferring new supplies of food, fuel, and equipment from Spektr to other parts of the complex. On June 5, one of Spektr's four solar arrays failed to fully unfurl because a restraint that held it in place for launch failed to release, and the crew was unable to extend it by sending pulses of power to the motor or by firing Mir's thrusters. TsUP controllers, aided by videos transmitted to them by the crew, began plans for a sixth EVA so that the cosmonauts could release the stuck array.⁵⁸

Thagard surpasses previous American record. Norm Thagard held a press conference on June 6, the day he surpassed the long-held record of U.S. human spaceflight duration of 84 days (set by the Skylab 4 crew from November 16, 1973 to February 8, 1974).⁵⁹

June 10-29, 1995

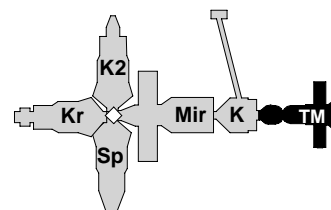

**Kvant 2
Kristall - Mir - Kvant - Soyuz-TM 21
Spektr**

Kristall relocated again. Before its last scheduled move of the Mir 18 mission, the cosmonauts had to install two new batteries in Kristall to boost its power supply enough to accomplish the undocking and redocking.⁶⁰ Then on June 10, the module was undocked from the -Z port, and again with use of the Lyappa, moved to the -X port.

American experiments activated. Thagard activated the American equipment inside Spektr, including two freezers for biomedical sample storage. On June 12 he began transferring previously collected samples to the freezers.⁶¹

Sixth EVA plans abandoned. After several discussions of an EVA to correct solar array problems on Spektr and Kvant 2, and to inspect the -Z port seal, NASA and RSA officials abandoned the plans for this mission. Reasons cited were insufficient planning time for the activities and lack of the proper tools for the solar array work. The two agencies jointly decided that there would still be enough power for the upcoming Atlantis docking and announced that launch of Atlantis on the STS-71 mission would take place on June 23.^{62,63} In the meantime, joint work on the creation, testing, and certification of new tools began. The Mir 19 crew was trained in the use of these tools before their launch to the station.⁶⁴

Mir 18 crew prepares for departure. Dezhurov, Strekalov, and Thagard began to prepare for their return to Earth, packing up experiments, biomedical samples, and other items to take back aboard Atlantis. They also concentrated on microgravity countermeasure exercises and spent time in the Chibis suit to prepare their cardiovascular systems for return to normal gravity.⁶⁵

Orbiter Docking System

For the docking at the Mir complex, a new Orbiter Docking System (ODS) had been installed on Atlantis on March 13. Although similar in design and operation to the docking system used for the Apollo-Soyuz Test Project in 1975⁶⁶, this docking system (fig. 6) is more complex, having more capability to accommodate larger space structures with greater center of gravity offset. The ODS structure can withstand 1000 kg of axial loads in the docked mode. The system weighs over 3500 lb, is 15 ft wide, 6.5 ft long, and 13.5 ft high. Mounted in Atlantis's payload bay, it includes a docking mechanism mated to a docking base attached to an external airlock, all of which is supported by a truss structure.⁶⁷ A camera is mounted on the center line of the system to transmit television images of the Kristall docking port during Atlantis's approach as an aid to the Atlantis commander during the manual phase of docking.⁶⁸

The 632-lb docking mechanism is an androgynous peripheral assembly system (APAS) built by RSC Energia in Russia and purchased for NASA by Rockwell International. The unit is alternately referred to as an androgynous peripheral docking assembly or system (APDA or APDS). The mechanism, based on a concept developed for the Buran space shuttle, will connect to the APAS-89 unit on the Kristall module.⁶⁹ It includes a capture ring and three guide petals, each with two capture latches. The capture ring is mounted to a base ring by six ball-screw shock absorbers that allow 6-degrees-of-freedom movement of the ring, and serve to damp out residual motion after capture, or soft docking. Twelve structural hooks on the base ring secure the mechanism to the docking unit on the other vehicle. The guide petals interact with those on the target APAS to align the two systems. After capture, the latches on the guide petals secure the two units, which are sealed by redundant silicone rubber O-rings. In the undocking procedure the latches are disengaged by a control switch on the Orbiter flight deck, and the two units are slowly pushed apart by preloaded springs.⁷⁰

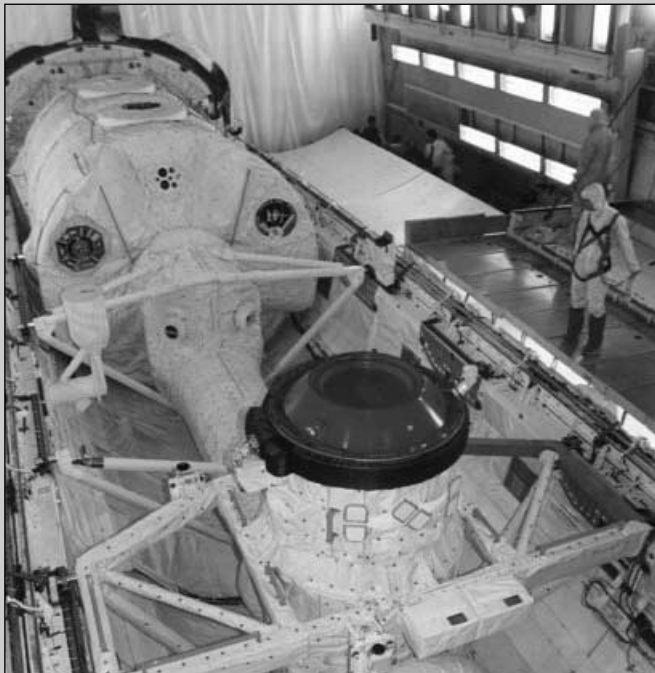
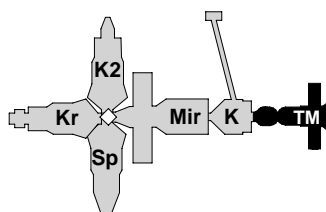

Figure 6. Orbiter Docking System is shown mounted in the payload bay of Atlantis. The dark circular structure in the foreground covers the androgenous peripheral assembly system, mounted on the docking base that protrudes from the supporting truss.

June 10-29, 1995



Concluded

Atlantis launched on STS-71 mission. After 4 days of delays caused by bad weather at Kennedy Space Center, Atlantis was launched on June 27 at 3:32 p.m. EDT. About 3 hr after launch, Gibson began a series of orbital maneuvering system (OMS) firings that would, through the next 2 days, take Atlantis to Mir's orbit, gradually decreasing the closing rate as well as the distance.⁷¹ On the second mission day, as they moved toward the station, Gibson, Precourt, and Dunbar began activating the Spacelab module in preparation for life sciences investigations. The crew extended the ODS docking ring to the docking position and found it in excellent working order.⁷²

Rendezvous techniques. After Gibson fired the terminal initiation burn, Atlantis was in a position to close in on Mir along the R-bar, or the line of the radius vector from Mir's center of mass to Earth. (The R-Bar approach had been successfully tested by Atlantis in retrieval of the German Crista-Spas satellite on STS-66 in November of 1994.) In this approach, gravity serves to slow the Orbiter's advance, thus reducing the need for jet firings and possible damage to Mir's solar arrays.⁷³ Atlantis jet firings in close proximity with Mir were done in low-Z with the use of jets on the nose and tail that, because of their offset position, would not fire directly at Mir. For Mir's part, its solar arrays were turned edge-on to minimize the effect of plumes. As Atlantis completed its final approach maneuvers, Mir's attitude was adjusted so that Kristall was in the correct docking position. At about 8 nmi below the station, Gibson took manual control of approach maneuvers, stopping at a distance of 250 ft from Mir to await a "go" for docking from ground controllers of both nations.⁷⁴

Dual ground control teams. Prefiguring the cooperation needed for ISS missions, a team of NASA flight controllers worked with TsUP controllers as consultants on Space Shuttle Orbiter systems and as liaisons between the U.S. and Russian ground support teams. In Houston, Russian flight controllers served similar functions in the NASA Mission Control Center. NASA Administrator Dan Goldin and RSA Director General Yuri Koptev, along with other Russian dignitaries, observed the docking from the TsUP.

June 29 - July 4, 1995

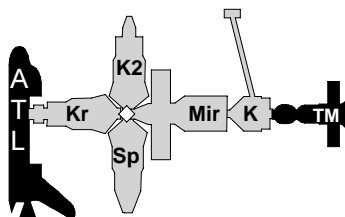

A Kvant 2
t - Kristall - Mir - Kvant - Soyuz-TM 21
l Spektr

Historic docking. On June 29 at 13:00 UTC, Gibson guided Atlantis to the docking port on the Kristall module and Harbaugh engaged the docking mechanism. The two spacecraft met 216 nmi above the Lake Baykal region of Russia (fig. 7). After pressurization and leak checks of the vestibule airlock, the two crews met and exchanged greetings and congratulations. There were ten of them, the largest crew ever aboard a single complex. The docked Mir and Atlantis totaled 220 tons, a record for orbiting spacecraft mass.^{75,76}

STS-71 Mission Highlights

June 27-July 7, 1995

Commander Robert L. Gibson (5th flight)
 Pilot Charles J. Precourt (2nd)
 Mission Specialist Ellen S. Baker (3rd)
 Mission Specialist Bonnie J. Dunbar (4th)
 Mission Specialist Greg Harbaugh (3rd)
 Cosmonaut Anatoly Solovyev (4th)-ascent
 Cosmonaut Nikolai Budarin (1st)-ascent
 Cosmonaut Researcher Norm Thagard (5th)-descent

Highlights: On STS-71, part of the series of joint U.S.-Russian missions comprising Phase I of the International Space Station program, Atlantis was the first Space Shuttle Orbiter to dock with Mir. It was the 100th human space mission for the U.S., the 69th Space Shuttle flight, and the 16th Atlantis flight. Major mission objectives all had international aspects:

- First rendezvous and docking of a U.S. Space Shuttle Orbiter with the Mir complex
- Transport to space of the Mir 19 crew, cosmonauts Anatoly Solovyev and Nikolai Budarin
- Return to Earth of the Mir 18 crew
- Conduct of the Shuttle-Mir Science Program, comprised of 28 on-orbit investigations aboard the Orbiter's Spacelab and Mir
- Logistical resupply of the Mir

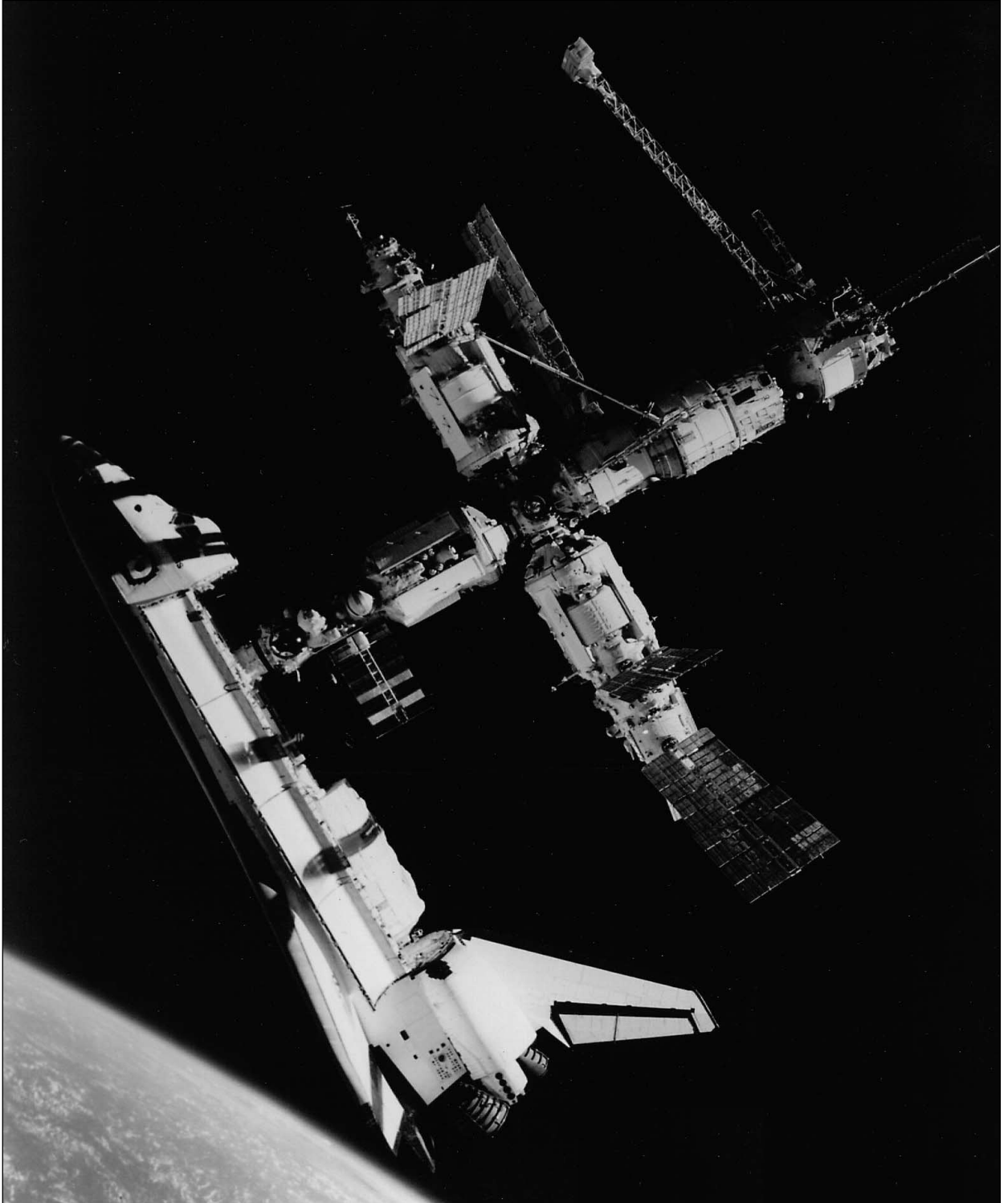

Figure 7. First docking of Atlantis with the Mir complex, during STS-71, June 29, 1995. Atlantis, with the aid of the new Orbiter Docking System, is docked with Kristall. Cosmonauts Solovyev and Budarin photographed the event from the temporarily undocked Soyuz-TM.

Mir Principal Expedition 19

Commander Anatoly Solovyev

Flight Engineer Nikolai Budarin

Crew code name: Rodnik

Launched in Atlantis (STS-71) June 27, 1995

Landed in Soyuz-TM 21, September 11, 1995

75 days in space

Highlights: The only complete Mir mission of 1995 with an all-Russian crew, Mir 19 had

many international elements. The first Mir crew launched on a Space Shuttle Orbiter, Solovyev and Budarin began their work in conjunction with a visiting U.S. crew and departing Mir 18 international crew. Two of their EVAs involved deployment and retrieval of international experiments. And they ended their stay by welcoming an incoming international crew.

Mir 19 crew officially take charge. Solovyev and Budarin officially assumed their duties aboard Mir on June 29. The Mir 18 crew moved their quarters to Atlantis for the duration of the STS-71 mission. Once there, they would continue their investigations of the biomedical effects of long-term space habitation.^{77,78}

June 29 - July 4, 1995

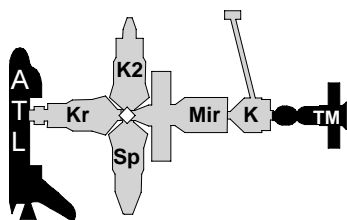

Continued

Triple cooperation. On June 30, the ten members of the Mir 18, Mir 19, and STS-71 crews assembled in the Spacelab on Atlantis for a ceremony during which they exchanged gifts and joined two halves of a pewter medallion engraved with likenesses of their docked spacecraft. The crews began transferring fresh supplies and equipment from Atlantis to Mir. They also moved medical samples, equipment, and hardware from Mir to Atlantis for return to Earth. New equipment included tools for an EVA to be performed by the cosmonauts to free the jammed Spektr solar array. Another commodity loaded onto Mir was water generated by Atlantis fuel cells.⁷⁹

Tests of docking effects. On July 1, Gibson and Precourt fired Atlantis's steering jets to change the station's attitude, to evaluate the integrity of the Mir-Atlantis docking mechanism and tunnel adapter during orbital maneuvers, and to test the effect of jet plumes on the station's solar arrays.⁸⁰

Goodbye again. After a farewell ceremony aboard Mir on July 3, the Atlantis and Mir 18 crew departed and began preparations on Atlantis for the next day's undocking. After the hatches of both spacecraft were closed, Harbaugh began depressurizing the transfer tunnel to equalize it with the vacuum of space before the separation of Atlantis from Mir.

The "cosmic ballet." On July 4, Solovyev and Budarin donned their flight suits, entered Soyuz-TM 21, and undocked from Mir to a stationkeeping position from which they photographed Mir and Atlantis, still docked. About 15 min later, Atlantis undocked from Mir when Gibson released the hooks that held the two craft together and allowed the docking system springs to nudge Atlantis away. As Atlantis slowly flew around the station, Soyuz-TM 21 redocked, and the two craft continued to

take pictures of each other and Mir. Gibson called this set of celestial maneuvers a “cosmic ballet.” However, the Soyuz module had to redock a few minutes sooner than planned when the Mir onboard computer which controls station attitude and solar array pointing malfunctioned. The station complex, about 10° off the correct attitude, was becoming unstable and starting to drift. The cosmonauts had to get back quickly to regain attitude control of the station. TsUP controllers left the station in free drift while the cosmonauts replaced attitude-control hardware in the computer.^{81,82,83}

July 4-17, 1995

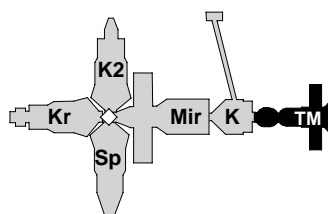

Kvant 2

Kristall - Mir - Kvant - Soyuz-TM 21 Spektr

Mir 18 crew completes 115-day mission. After Atlantis left the Russian space station, the homeward-bound Mir 18 crew continued their medical and scientific investigations in the Spacelab module in Atlantis’ payload bay. They used the lower body negative pressure unit and a baroreflex neck cuff to test cardiovascular orthostatic function response to microgravity. They also continued their daily exercise sessions on the treadmill. During Atlantis’ reentry and landing on July 7, they rode in special recumbent seats that allowed them to take the force of reentry in a reclining position. After the landing at Kennedy Space Center’s Shuttle Landing Facility, they were flown in an Air Force C-9 Medevac plane to Ellington Field in Houston. They followed up their spaceborne biomedical investigations with medical tests at Johnson Space Center.⁸⁴

First EVA of Mir 19. Before their launch, Solovyev and Budarin had trained to use the new tools created for releasing the stuck Spektr solar array. On July 14, they exited the Kvant 2 hatch and made their way to Spektr using the Strela boom. They quickly cut the offending restraint, and all but one section of Spektr’s jammed solar array deployed.⁸⁵ Then they were able to route the power input to the complex. They inspected the -Z port docking mechanism and found no signs of damage or pollution, clearing the port for relocation of the Kristall module. Before reentering the Kvant 2 hatch, they inspected one of that module’s solar arrays which was not tracking the sun correctly. The EVA ran 5 hr and 34 min, about 20 min over the originally budgeted time.^{86,87}

July 17-22, 1995

Kristall Kvant 2
- Mir - Kvant - Soyuz-TM 21
Spektr

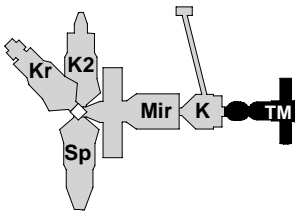

Kristall relocated once more. In a 90-min session on July 17, Kristall was transferred by means of its Lyappa arm to the -Z docking port from the -X port, where Progress-M 28 would dock later in the month.⁸⁸ The rearrangement placed Kristall in the proper position for the next Atlantis docking, during STS-74 in October. Figure 8 shows the resulting configuration of the complex. Solovyev inspected the air seal at the -Z port and found it intact.⁸⁹

Problems during second Mir 19 EVA. The primary purpose of the second space walk (July 19) was to deploy the Belgian-French MIRAS (Mir infrared spectrometer) on the far end of the Spektr module. But minutes after the EVA began, Solovyev's Orlan-DMA suit cooling system malfunctioned and the TsUP ordered him to stay attached by an umbilical to Kvant 2. The MIRAS deployment had to be postponed, but Budarin was able to do some preparatory work alone. He also retrieved the American cosmic ray detector, TREK, which had been on the Kvant 2 surface since 1991, and switched out cassettes of sample construction materials as part of an ongoing space exposure experiment. His time outside totaled 3 hr, 8 min. But the troubles were not all over: After closing the Kvant 2 EVA hatch, the cosmonauts found a 2-mm gap in the seal through which air was escaping. They had to work with the hatch to get it tightly shut.^{90,91}

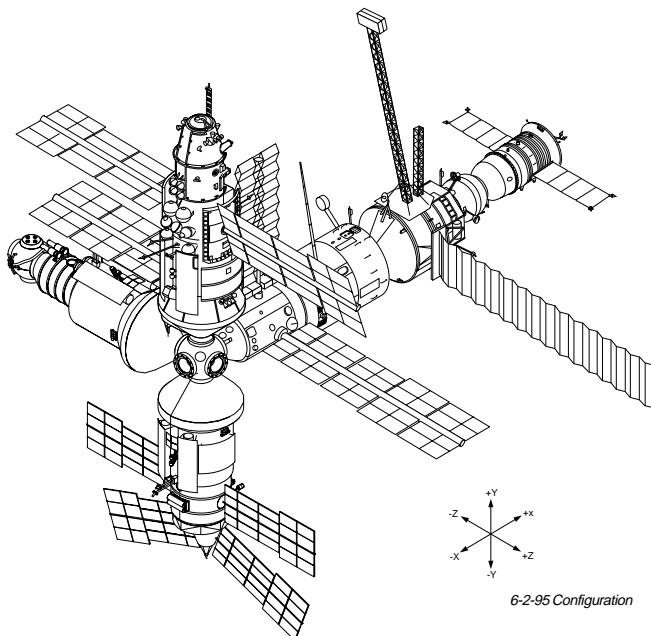
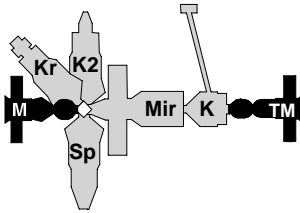

Figure 8. The Mir complex as configured after multiple relocations of Kristall to accommodate Spektr docking and subsequent relocation to the -Y port on June 2, 1995. Spektr is shown at the bottom of the complex in this orientation.

July 22 - September 4, 1995



Kristall Kvant 2
Progress-M 28 - Mir - Kvant - Soyuz-TM 21
Spektr

Progress-M 28 arrives. Launched by a Soyuz booster from Baikonur on July 20, Progress-M 28 module bore 2.4 t of food and water, fuel and oxidizer, and science equipment (including about 335 kg for use during Euromir 95). Two days later, using the Kurs system, Progress-M 28 docked at the -X port of the base block.⁹²

Installation of MIRAS during third EVA. On July 21, the cosmonauts opened the Kvant 2 hatch again and retrieved the cooling umbilical left outside in their last EVA. Using the Strela boom, they made their way to the Spektr module, on which they installed the 220-kg MIRAS spectrometer. This final EVA of Mir 19 lasted 5 hr, 35 min.⁹³

Interior work throughout August. With their EVAs completed, the Mir 19 crew turned their attention to experiments in life sciences and astrophysics and smelting experiments in the Gallar furnace. They unloaded the cargo brought by the Progress module and monitored the automatic refueling by Progress of the base block propellant tanks. They also performed station maintenance and repairs, including installation in Kvant 2 of new gyrodynes brought up on Progress. They repaired the seals on other gyrodyne cases with a lute-type sealer called “germetik.”^{94,95,96}

September 4-5, 1995

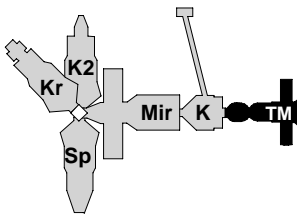

Kristall Kvant 2
Mir - Kvant - Soyuz-TM 21
Spektr

Progress-M 28 undocks. Packed with trash and obsolete equipment, Progress-M 28 left the -X port on September 4 and splashed down into the Pacific, thus clearing the way for Soyuz-TM 22 to dock with the next Mir crew.

Mir Principal Expedition 20 and Euromir 95

Commander Yuriy Gidzenko (1st flight)
 Flight Engineer Sergey Avdeyev (2nd)
 ESA Cosmonaut Researcher/Flight Engineer
 Thomas Reiter (1st)

Call name Uran

Launched and landed in Soyuz-TM 22,
 September 3, 1995-February 27, 1996
 179 days in space

Highlights. Mir 20 was a harbinger of the multinational missions that will be typical of International Space Station. It was the second Mir mission with a simultaneous Euromir designation, the second with an ESA astronaut as part of the crew. (Ulf Merbold, the first ESA

astronaut aboard Mir, conducted Euromir 94 in October and November of 1994.)

Thomas Reiter was the first non-Russian Mir crew member with the designation Flight Engineer. The scientific objectives of Euromir 95 were to study effects of microgravity on the human body, to experiment with the development on new materials in a space environment, to capture samples of cosmic dust and man-made particles in low Earth orbit, and to test new space equipment. Mir 20 was also the second Mir mission to include a U.S. Space Shuttle Orbiter docking. During that phase of the mission, the station complex housed crews from four countries, representing the Russian, Canadian, and U.S. space agencies as well as ESA.

Mir 20 and Euromir 95 crew launched. Soyuz-TM 22 was launched from Baikonur on September 3 at 08:58 UTC. Russian Space Forces controlled the launch, with a switchover to TsUP after separation of the manned capsule from the Soyuz-U launcher. ESA Director for Manned Spaceflight and Microgravity, Jorg Feustel-Büechl, said that the mission would “provide European scientists with unprecedented data on long duration spaceflight and further strengthen ESA’s relationship with the Russian space programme.”⁹⁷

September 5-11, 1995

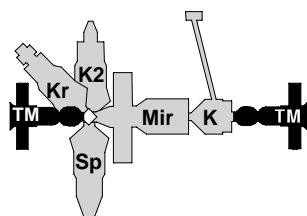

Kristall Kvant 2

Soyuz-TM 22 - Mir - Kvant - Soyuz-TM 21
 Spektr

Soyuz-TM 22 docks. After 2 days of autonomous orbital flight toward Mir, on September 5 the Soyuz spacecraft circled the station from 90 to 120 m out, then made a successful automatic docking at the -X docking port. About an 1.5 hr later, the crew checked the hatch seals, removed their pressure suits, and entered the station to be met by Solovyev and Budarin with greetings and the traditional bread and salt.⁹⁸ Then the two crews began a week of joint work, including briefings from the Mir 19 crew to familiarize their replacements with the status of onboard systems and experiments.

September 11 -
 October 10, 1995

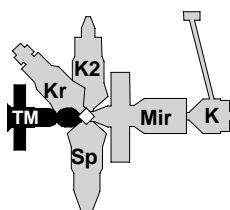

Kristall Kvant 2

Soyuz-TM 22 - Mir - Kvant
 Spektr

Mir 19 ends. Solovyev and Budarin ended their 75-day mission on September 11, departing the station in the Soyuz-TM 21 that had brought the Mir 18 crew up on March 16. Their Soyuz made a safe landing in Kazakhstan, 302 km northeast of Arkalyk,

**September 11 -
October 10, 1995**

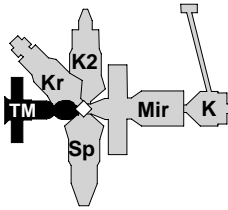

Concluded

“far away from the aiming point.” Rescue parties, however, found the crew in excellent condition.⁹⁹

Euromir science activities begin. The Mir 20 crew began activating and calibrating the Euromir 95 experiments on September 13. The 41 experiments included 18 in life sciences, 5 in astrophysics, 8 in materials science, and 10 in technology.

- Life sciences experiments were mostly investigations of weightlessness effects on the human body, including
 - ♦ Cardiovascular monitoring through a network of blood pressure sensors at various points on the body
 - ♦ Bone-mass-loss studies done by simulating heel striking in weightlessness
 - ♦ Studies of the effects of weightlessness on kidney, lung, and muscle functions
- A major astrophysics study involved capturing and analyzing natural and man-made particles in low Earth orbit in the European Space Exposure Facility (ESEF) on Spektr
- Technology experiments included
 - ♦ Radiation monitoring to study the effects of the space environment on electronic components
 - ♦ Methods of measuring microbial contaminants in the station interior
 - ♦ Measurement of disturbances produced by the movements of a small robotic arm
- Many of the materials science experiments involved the processing of alloy, glass, and semiconductor samples in TITUS, a six-zone tubular furnace capable of attaining 1250°C

An average of 4.5 hr a day was allotted for experiment work, with the rest of the time devoted to exercise and station maintenance.¹⁰⁰ The Mir 20 crew was active in the Euromir experiments and the ESA crew member, German Thomas Reiter, in addition to his Euromir duties, participated in Russian experiments and, as flight engineer, helped maintain the station’s onboard equipment.

**October 10 -
November 15, 1995**

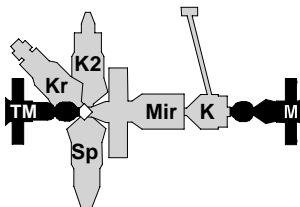

**Kristall Kvant 2
Soyuz-TM 22 - Mir - Kvant - Progress-M 29
Spektr**

Progress-M 29 arrives. Another Progress-M vehicle was launched from Baikonur at 18:51 UTC on October 8 by a Soyuz-U. The cargo module docked with Mir at 20:23 UTC on October 10 with about 2.5 t of fresh supplies and equipment for the Mir 20 crew. Included was about 80 kg of additional experiment hardware for Euromir 95, such as the cassettes to be installed during an EVA in the ESEF on the exterior of Spektr. After some problems opening the hatch, the crew entered Progress-M 29 and began inspecting and unloading the cargo.¹⁰¹

**October 10 -
November 15, 1995**

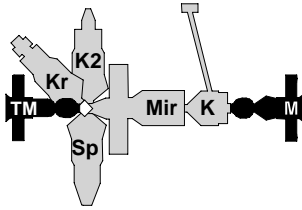

Continued

Mir 20/Euromir 95 extended. ESA and Russian organizations officially announced on October 17 the decision to add 44 days to the joint mission, originally scheduled to be 135 days long. The possibility of extending the mission had been discussed even before launch. The final decision was made on October 6 at a meeting of the RSA, ESA, RSC Energia, the Russian Central Specialized Design Bureau (Soyuz rocket designer), and representatives of the Progress Plant where the Soyuz-U booster for launch of the next crew (Mir 21) was under construction. Postponing the Soyuz-TM 23 launch from January 15, 1996, to February 21, 1996, would shift much of the expenditure for launch vehicle processing to the next fiscal year, thus relieving a strain on the RSA budget. It would also optimize resource use by keeping the Soyuz-TM 22 module attached to the station for its full 180-day lifetime. The extension to February 27, 1996, would allow time for additional Euromir scientific research and an extra EVA. In December a new Progress-M would provide extra consumables for the crew and equipment for additional Euromir experiments.^{102,103,104,105}

EVA Preparations. The Mir 20 crew spent about 5 days preparing for their first EVA—assembling and checking the hardware they were to deploy, then placing it in an EVA bag that would keep items from floating away during the work on the ESEF.¹⁰⁶

First Mir 20/Euromir 95 EVA. In the first space walk by an ESA astronaut, Reiter climbed through the Kvant 2 hatch on October 20, with Avdeyev close behind. Reiter tethered himself and the bag of experiment hardware to the Strela boom. Avdeyev turned the crank at the base of the boom to move Reiter to the forward section of the Spektr module, then climbed the length of the boom himself. In a successful 5-hr, 11-min EVA, they installed four elements on the ESEF—two exposure cassettes, a spacecraft environment-monitoring package, and a control electronics box. The two clam-like cassettes could be controlled remotely from within the station. (One would be opened to sample space debris except during dockings, when it would be closed to avoid contamination; the other would be opened to sample the Draconids meteor stream when Earth passed through the tail of comet Giacobini Zinner.) Gidzenko powered up the experiments and tested their operability from inside Mir. The two spacewalkers then changed the cartridges in the nearby Russian-Swiss Komza exposure experiment, also on Spektr.^{107,108,109}

Coolant loop leak discovered and repaired. A leak in a coolant line to the Kvant/core module air regeneration system was found on November 1. Approximately 1.8 L of a solution containing 37° ethylene glycol had leaked inside the Mir module. The coolant loop had to be shut down; thus the primary carbon dioxide removal system in Kvant and the oxygen replenishing system were disabled. The leak was found a few days later and repaired with a “putty-like substance.” Meantime, a backup air scrubber using lithium hydroxide canisters similar to those used on the U.S.

**October 10 -
November 15, 1995**

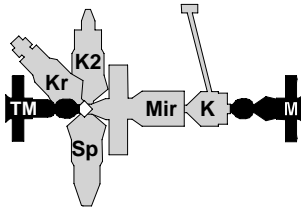

Concluded

Space Shuttle was substituted to remove the carbon dioxide. The solid oxygen generators and the Kvant 2 alternate oxygen system could be used for oxygen production until the mid-December Progress-M launch. U.S. and Russian ground support teams began immediately planning solutions. They decided that Atlantis would bring extra Space Shuttle lithium hydroxide regeneration canisters and a fixture developed at NASA's Johnson Space Center to connect the canisters to Mir's air supply system.^{110,111}

Dutch Biokin Air Scrubber Tested. The Biokin experiment, an innovative air filtration system that uses microbes to convert airborne contaminants to harmless compounds, was activated by the crew on November 9. After a week of operation, the air scrubber was deactivated and put in a small freezer for return to Earth on STS-74. The 500-gm system was designed by two Dutch companies and jointly sponsored by ESA and the Dutch National Institute for Aerospace Programs (NIVR).¹¹²

STS-74 launch. After a one-day launch delay caused by poor weather at the transatlantic abort site, Atlantis was launched from Kennedy Space Center at 7:30 a.m. EST on November 12, 1995. On the first two days of the flight, Cameron and Halsell executed a series of reaction control jet firings to gradually bring Atlantis closer to Mir.

Docking Module placement preparations. The crew prepared for on-orbit assembly of the Docking Module atop the ODS mechanism inside the payload bay. The module had been launched in the aft portion of the payload bay to provide center-of-gravity control and to allow the bay doors to close. On mission day 1, Hadfield activated the module for a system check. On day 2, Hadfield powered up and checked out the RMS mechanical arm. Mission specialists Ross and McArthur checked out their space suits in case they had to go outside the pressurized area of Atlantis for contingency operations during either the mating of the Docking Module to the ODS or the subsequent docking of Atlantis with Kristall. Other crew tasks included checkout of the ODS and the OSVS, as well as installation and alignment of the ODS centerline camera.

Docking Module on-orbit assembly. On mission day 3, Hadfield powered up the OSVS. Then with McArthur's assistance, he grappled the Docking Module with the 50-ft RMS and removed it from its moorings in the payload bay, lifting it horizontally out of the bay. When it was clear of all structures, he pivoted the module 90° to a vertical position, spun it almost 180°, and brought it over the ODS. After Hadfield placed the arm in a "limp" position (with no power on, no mechanical parts working), Cameron fired Atlantis's steering thrusters to gently bring the two docking systems together, thus engaging the hooks and latches which locked the Docking Module to the ODS. After tests to confirm a secure engagement and removal of the mechanical arm, the crew mounted a centerline camera on the Docking Module's top hatch to be used in the next day's docking with Mir.^{113, 114}

STS-74 Mission Highlights

November 12-13, 1995

Kenneth D. Cameron, Commander
(3rd flight)

James D. Halsell, Pilot (2nd)

Jerry L. Ross, Mission Specialist (5th)

William S. McArthur, Jr, Mission Specialist
(2nd)

Chris A. Hadfield, Mission Specialist (1st)

Highlights. STS-74 was the second in the series of joint Shuttle-Mir missions planned before assembly of the International Space Station. This flight was the last of U.S. Space Shuttle's seven missions in 1995, three of which had Mir rendezvous or docking among

their major objectives. It was the 15th flight for Atlantis, the 73rd U.S. Space Shuttle flight. When its five-member crew, including Canadian Chris Hadfield, joined the Mir 20/Euromir crew, four different nations—Canada, Germany, Russia, and the U.S.—were represented on one mission in the same orbiting complex. In addition to the docking itself, a major objective of the mission was to deliver a new Russian-built Docking Module (DM) and new solar arrays to Mir. Hadfield, using the Canadian-built Remote Manipulator System (RMS), attached the Docking Module to the Mir Kristall module. The solar arrays, stowed in containers on the shell of the docking module, would be deployed in later missions.

Docking Module

Specifications

launch weight—approx. 4090 kg

length—4.7 m

diameter—2.2 m

Description

Concept discussions for the module began in November 1993 and were finalized in June 1994. It was designed and built during 1994 and 1995 in Russia by RSC Energia for the RSA. NASA and American space contractor Rockwell Aerospace provided technical oversight. After final assembly and functional tests in Russia, the module was delivered to Kennedy Space Center on June 7, 1995. There it had the distinction of being the first article made flight-ready in the new Space Station Processing Facility, which had opened in March. By September 11, it was ready for installation in the aft payload bay of Atlantis.^{115, 116}

The new module (figure 9) simplified U.S. Space Shuttle Orbiter dockings with Mir by eliminating the need to move Kristall to the -X port at Mir's longitudinal axis each time an Orbiter visits. That port is free for the Progress and Soyuz dockings, and Kristall can remain docked at the radial port. Another consideration in the addition of the Docking Module was that Kristall's Lyappa arm, used in its moves from port to port, would reach its design lifetime before all the planned Orbiter dockings were accomplished. Also, the Docking Module's 4.7-m length provides extra clearance between the Orbiter and the Mir solar arrays as the Orbiter approaches Kristall.^{117, 118}

The identical androgynous peripheral assembly systems (APASs) at each end of the new module are compatible with existing systems on Kristall and Atlantis. APAS-1 is attached to Kristall; APAS-2 will receive the Shuttle ODS in future dockings of Atlantis.¹¹⁹ Visiting crews enter the pressurized interior through the APAS-2 hatch. From there they access Kristall (and thus Mir) through the APAS-1 hatch.

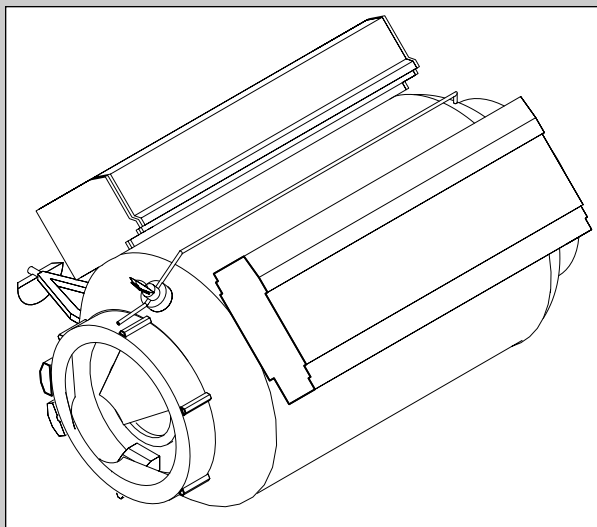

Figure 9a. The Russian-designed Docking Module which was added to Kristall in November 1995 to accommodate future Space Shuttle dockings with the Mir complex. An APAS mechanism shows at the end of the module (left side of drawing). The module was transported to Mir by Atlantis on STS-74.

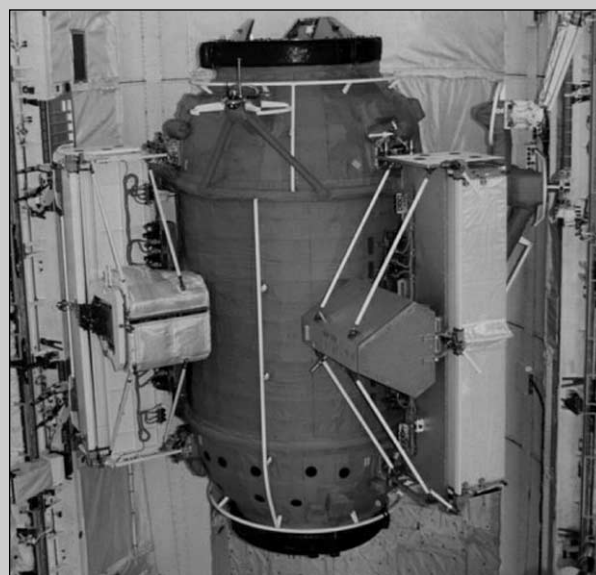

Figure 9b. The Docking Module in Atlantis' payload bay before launch of the STS-74 mission.

The cylindrical aluminum alloy module is protected in the orbital environment by a micro-meteoroid shield and a passive layer of screen vacuum thermal insulation. Further thermal control for the pressurized interior is provided by a coolant loop; there are also fans for the avionics and the APAS window.

Because the docked module obscured the Orbiter commander's line of sight to his Kristall docking port target, a new Orbiter space vision system (OSVS) was tested on STS-74. It consisted of a series of large dots on both the Docking Module and the ODS.¹²⁰

STS-74 Solar Array Package

Two solar array containers are attached to the exterior of the Docking Module for later deployment. In one is stowed the Mir Cooperative Solar Array (MCSA), in the other an all-Russian solar array. The MCSA, designed as part of the International Space Station Phase 1 program, uses a Russian structural frame and 80 NASA silicon photovoltaic cells. It will provide 6 kW of power through 42 segments that will measure 9 by 60 ft when deployed. Solar arrays on the International Space Station will use the same type of U.S.-made silicon cells.^{121, 122}

November 15-18, 1995

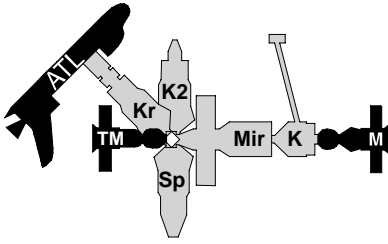

Atlantis

Kristall Kvant 2
Soyuz-TM 22 - Mir - Kvant - Progress-M 29
Spektr

Second Shuttle-Mir docking. As Atlantis approached Mir on the fourth day of the STS-74 mission, the crew augmented Atlantis's navigation computer and trajectory control system laser with a handheld laser to provide precise targeting information. With Atlantis lined up with Mir along the R-bar, approaching the station from beneath, Cameron began manual control of the Orbiter. The newly installed centerline camera helped him obtain alignment coordinates with Kristall's docking port, now obscured by the protruding Docking Module. After a "go" from Russian and U.S. ground controllers, Cameron slowed the Orbiter's approach to less than one in/sec and successfully docked with the station at 1:28 a.m. EST on November 15 in an orbit 216 nmi above western Mongolia.¹²³ About 2.5 hr later, after docking verification and seal checkouts, Cameron opened the Docking Module hatch and met Mir Commander Gidzenko inside the new module. A handshake between the two commanders signaled the formation of a multinational crew.¹²⁴

Multinational crew activities. After traditional greetings, the crews got to work transferring cargo items between the visiting Orbiter and Mir. Supplies carried into the station during the 3 days the two vehicles were docked included over 300 lb of food, over 700 lb of experiment equipment, about 900 lb of by-product water from fuel cells in Atlantis,¹²⁵ and 20 lithium hydroxide canisters to serve as backups to Mir's recently repaired primary carbon dioxide removal system. From Mir, the crews removed about 800 lb of research samples collected during Euromir 95 and experiment equipment no longer needed on the station. In addition to talking to the press on the ground, the crews received congratulations from Russian Prime Minister Viktor Chernomyrdin, Canadian Industry Minister John Manley, NASA Administrator Daniel Goldin, and U.N. Secretary General Boutros Boutros-Ghali.^{126, 127}

Joint spacecraft experiments. While the space vehicles were docked, the crews cooperated in medical experiments and environmental investigations designed as part of International Space Station Phase I research. Examples of the studies conducted by the Shuttle and Mir crews were

- The Photogrammetric Appendage Structural Dynamics Experiment (PASDE), a set of three photogrammetric instruments located throughout the Orbiter payload bay, recorded Mir solar array structural dynamics during docking and the docked phase of the mission, gathering data for future missions.

November 15-18, 1995

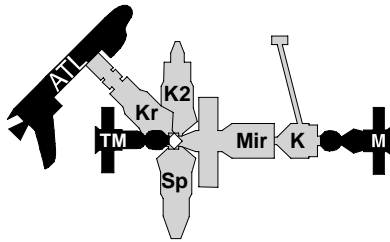

Concluded

- International Space Station Risk Mitigation Experiments evaluated the acoustic environment aboard Mir, remote communications systems, and the alignment stability of the Atlantis-Mir docked configuration.
- Inflight radiation measurements, for which both crews wore passive dosimeters. They gathered data about the orbital radiation environment and compared the techniques and equipment used by NASA with those used by the Russian Institute for Biomedical Problems.
- A series of jet firings by both Mir and Atlantis evaluated the dynamics of the complicated structure of the docked spacecraft, which, at more than 500,000 lb, set a new record for conjoined orbital mass.^{128, 129}

November 18 -
December 19, 1995

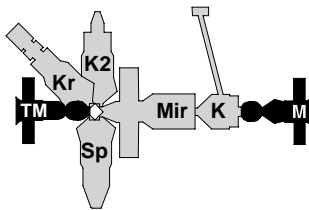

Kristall Kvant 2
Soyuz-TM 22 - Mir - Kvant - Progress-M 29
Spektr

Docking phase ends. Early on the morning of November 18, Cameron activated the springs to push the ODS free of the Docking Module and slowly undocked Atlantis. At two ft out, he activated the reaction control system to move the Orbiter away from the Mir complex. At about 525 ft out, he began a fly-around. Atlantis circled Mir twice, taking a photographic survey of the station (fig. 10). Four and a half hr after undocking, Cameron fired the orbital maneuvering system to lower Atlantis to another orbit.

STS-74 mission ends. After their successful Mir mission, the crew of Atlantis, on their own once again, began closing down their experiments and stowing equipment that had been used in flight. On November 20, at 12:02 p.m. EST, they landed at Kennedy Space Center, Florida, ending their 129-orbit mission after 8 d, 4 hr, and 31 min.

Euromir experiments resume. After the departure of Atlantis, the Mir 20 crew continued with Euromir 95 activities, including medical tests and materials processing experiments. In addition to the equipment brought to Mir expressly for Euromir, Reiter used the Austrian Optovert equipment that had been on Mir since the Austro-Mir mission in October 1991. With it he investigated the effects of weightlessness on human motor system performance and the interactions of the vestibular system and visual organs.¹³⁰

Gyrodyne maintenance. The cosmonauts did preventive maintenance on the Kvant 2 gyrodynes in late November, using the attitude control jets to maintain station orientation while the gyrodynes were inactive.¹³¹

**November 18 -
December 19, 1995**

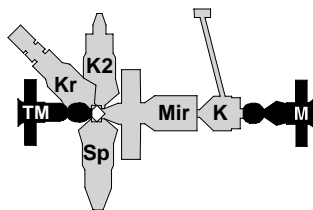

Concluded

Space art contest. On November 30, the crew announced the three winners of an art contest sponsored by the Swiss-based OURS foundation. Twenty of 171 entries on the theme of "Space and Humanity" had been selected by a panel for the journey to orbit with the Mir 20/Euromir crew. From these 20, the crew chose the three finalists.¹³²

Second Mir 20 EVA. On December 8, the crew reconfigured the docking unit at the front of the Mir base block to prepare it to receive the 1996 Priroda module. From inside the depressurized docking unit, the Orlan DMA-suited crew moved the Konus docking unit from the +Z to the -Z docking port, where Priroda would dock in the spring.¹³³

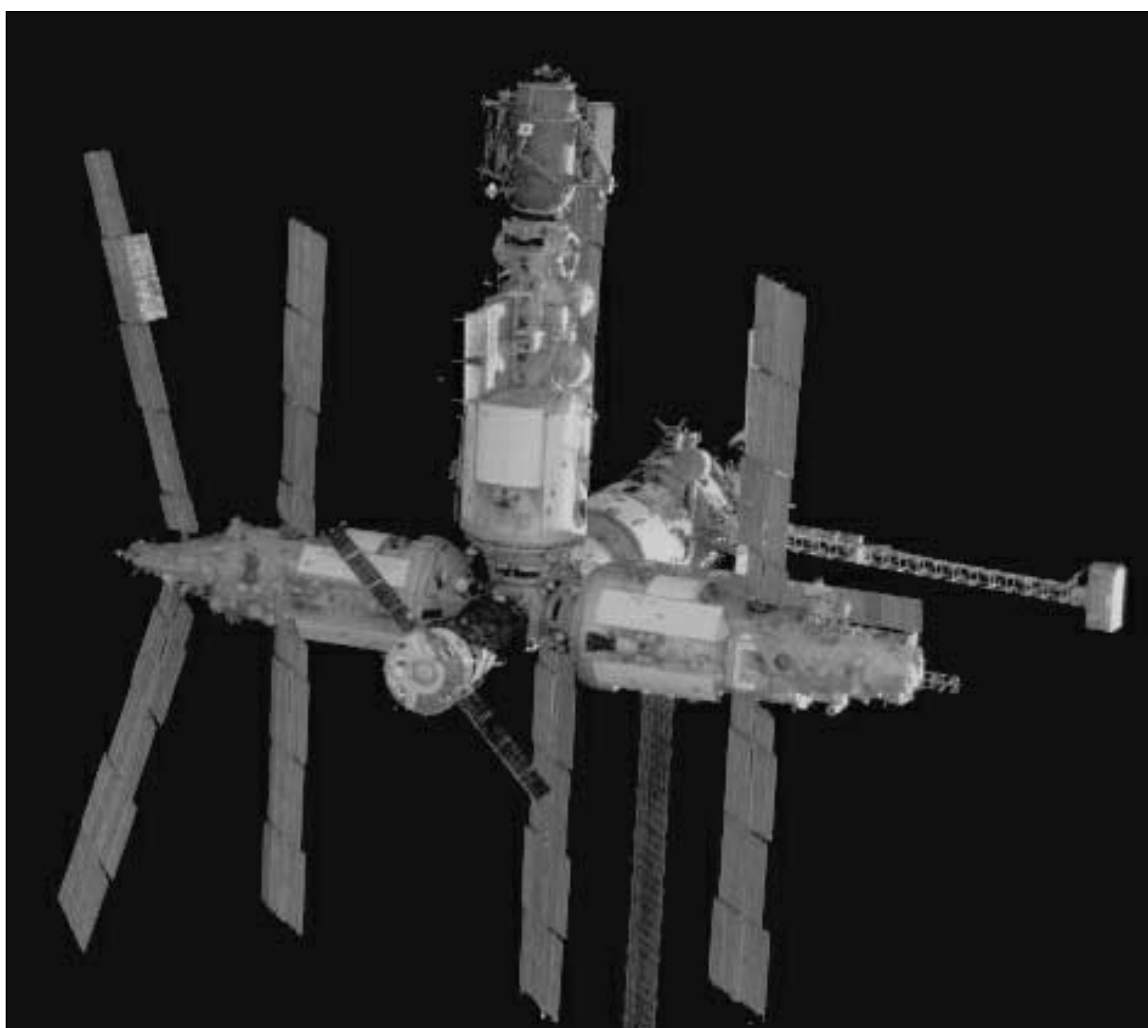
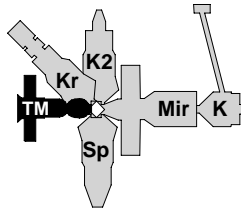

Figure 10. Mir with new docking module (top, center of photo) installed on the Kristall module. The photo was taken by the departing Atlantis on STS-74. Spektr is shown at the left, Kvant 2 at the right.

December 19-20, 1995



Kristall Kvant 2
Soyuz-TM 22 - Mir - Kvant
Spektr

Progress-M 29 departs. On December 19, Progress-M 29 undocked from the rear Kvant port and deorbited over the Pacific.

December 20, 1995 -
February 22, 1996

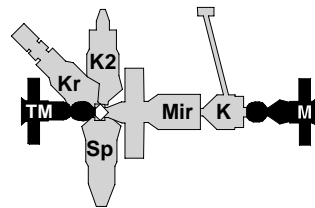

Kristall Kvant 2
Soyuz-TM 22 - Mir - Kvant - Progress-M 30
Spektr

Progress-M 30 resupplies Euromir 95. Progress-M 30 was launched on December 18 from Baikonur on a Soyuz-U rocket. It docked at the vacated Kvant port on December 20 with 2300 kg of fuel, crew supplies, and research and medical equipment for use on the extended Euromir 95 mission.¹³⁴ This was the last of five Progress-M dockings at Mir in 1995.

Experimentation continues into new year. As 1996 began, the crew continued their experiments. Reiter took biomedical samples and measurements and tested the capacity of uncooled melts in the TITUS materials processing furnace. The Russian cosmonauts studied microgravity effects on hydrodynamics with the Volna-2 device, using models of spacecraft fuel system elements. With the Maria magnetic spectrometer, they investigated possible links between terrestrial seismic activity and high-energy charged cosmic particle fluxes.¹³⁵

Reactivation of Kvant coolant loop. Between January 12 and 16, 1996, the cosmonauts resumed work on the cooling system leak that had begun in November. They hermetically sealed a manifold on the coolant line, then refilled the loop with ethylene glycol that had been sent up on Progress-M 30 to replace that lost at the onset of the leak. Following the repair, they continued their Euromir 95 materials processing experiments with melting and recrystallization of metals.¹³⁶

Third Mir 20 (second Euromir 95) EVA. At the beginning of their EVA on February 8, Reiter and Gidzenko moved a maneuvering unit, referred to as the SPK or YMK, stored inside the Kvant 2 airlock and attached it to the exterior of the module. (The large unit, which had not been used since it was tested in 1990, was in the way of spacewalkers preparing to exit the airlock.)^{137, 138} The cosmonauts then climbed out the Kvant 2 hatch and again used the Strela boom to maneuver to the forward end of Spektr, where they retrieved the two cassettes they had

**December 20, 1995 -
February 22, 1996**

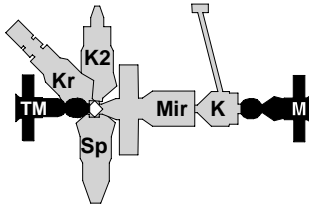

Concluded

deployed in October on the ESEF. They installed a new cassette in the facility and, with Adeyev's assistance from inside the station, verified that it would operate. Their work took only 3 hr and 6 min. Originally scheduled to last about 5.5 hr, the EVA was shortened by an aborted task on a Kristall antenna. The TsUP canceled the antenna work when the cosmonauts were unable to loosen the bolts on a joint of the antenna.^{139, 140}

Tenth anniversary of base block launch. As the Mir base block marked the 10th anniversary of its launch to orbit on February 19 (February 20 in Moscow), ITAR-TASS reported a "holiday atmosphere" aboard the complex. Having already remained in orbit four years longer than was originally intended, the base block, with its complement of docked modules, held the promise of at least three more orbiting anniversaries.¹⁴¹

February 22 -23, 1996

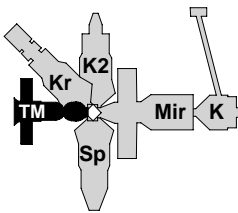

**Kristall Kvant 2
Soyuz-TM 22 - Mir - Kvant
Spektr**

Progress-M 30 undocked and Soyuz-TM 23 launched. On February 21, Soyuz-TM 23 was launched from Baikonur with the Russian crew members for Mir Principal Expedition 21. Progress-M 30 was undocked on February 22 and commanded to a destructive reentry over the Pacific.¹⁴²

Mir Principal Expedition 21

Commander Yuri Onufrienko (1st flight)

Flight Engineer Yuri Usachev (2nd)

Launched and landed in Soyuz-TM 23-
February 21 - September 2, 1996
194 days in space

Cosmonaut Researcher Shannon Lucid (5th)

Launched on Atlantis (STS-76)-March 22, 1996

Landed in Atlantis (STS-79)-Sept. 26, 1996
188 days in space

Crew code name: Skif

Highlights: Onufrienko and Usachev began their mission without the third crew member, American astronaut Shannon Lucid, who would join them in late March during STS-76, the third Atlantis-Mir docking mission. On one of the seven EVAs of Mir 21, U.S. astronauts walked outside Mir for the first time; on two others, the cosmonauts installed a new solar array on the Kvant module. The last permanent module was added to the complex—Priroda, with its large complement of Earth science experiments.

February 23-29, 1996

**Kristall Kvant 2
Soyuz-TM 22 - Mir - Kvant - Soyuz-TM 23
Spektr**

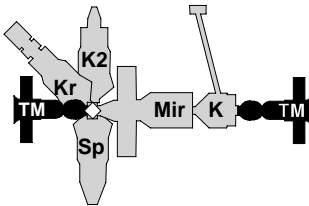

Soyuz-TM 23 delivers Mir 21 crew. The Soyuz module docked on February 23 at the +X docking port at the rear of the Kvant module. About an hr and a half after docking, the hatches were opened and Onufrienko and Usachev were greeted by the Mir 20/Euromir 95 crew, who would remain with them a week to familiarize them with current conditions and projects on the station. The week of joint operations also included work with crop breeding experiments and Earth observation spectrometry. The Mir 20 crew made preparations for their departure, including checks of Soyuz-TM 22 systems and sessions in the Chibis negative-pressure suit to condition them for return to Earth gravity.¹⁴³ Two days before the return flight, a water leak appeared in the Mir base block, but the cosmonauts solved it with advice from ground support.¹⁴⁴

February 29 - March 23, 1996 **Kristall Kvant
- Mir - Kvant - Soyuz-TM 23
Spektr**

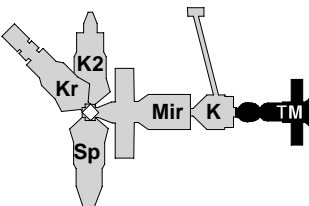

Mir 20/Euromir Mission ends. On February 29, Gidzenko, Avdeyev, and Reiter donned their Sokol launch and entry suits and entered Soyuz-TM 22. They landed safely about 105 km from Arkalyk. Recovery teams had erected facilities for rapid medical tests before the crew was returned to Star City that evening. Their mission had lasted 179 days, 1 hr, and 42 min.¹⁴⁵ Reiter thus achieved a record for spaceflight duration by a West European.

First EVA for Mir 21. On March 15, Onufrienko and Usachev exited the Kvant 2 EVA hatch for their first space walk. Because

February 29 - March 23, 1996

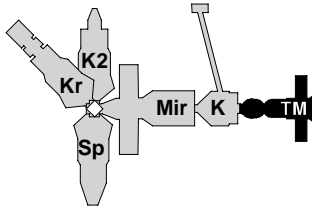

Concluded

the existing Strela could not be used to reach the Kristall module in its current location, they installed a second Strela boom on the Mir base block, on the side opposite the Strela already in place. In the 5-hr, 51-min EVA, they also prepared cables and electrical connectors on the surface of the Kvant module for the May installation of the Mir Cooperative Solar Array.^{146, 147} The array was stored on the surface of Docking Module that was installed on Kristall last November.

STS-76 Mission Highlights

March 22 - 31, 1996

Kevin Chilton, Commander

Rick Searfoss, Pilot

Ron Sega, Payload Commander, Mission Specialist

Rich Clifford, Mission Specialist

Linda Godwin, Mission Specialist

Shannon Lucid, Mission Specialist (joins the Mir 21 crew as Cosmonaut Researcher)

Highlights: The chief objectives of STS-76 were its third docking of Atlantis with the Mir station, the first space walk by U.S. astronauts during a Shuttle-Mir docking, and the delivery to the station of a new Mir-21 crew member, bio-chemist/pilot Shannon Lucid. Lucid was the first American woman to serve as a Mir station researcher.

Atlantis launched. The U.S. Space Shuttle Orbiter Atlantis was launched from Kennedy Space Center on March 22 at 7:00 a.m. CST for its sixteenth flight. During the ascent phase, flight controllers detected a small leak in one of Atlantis's three redundant hydraulic systems, but after the system was shut off when Atlantis reached orbit, the leak stopped. The approximately 20% loss of that one system's hydraulic fluid would not adversely affect the mission because the hydraulic system would not be used again till the descent phase.¹⁴⁸

Preparations for docking. During the first two days of the mission, Chilton and Searfoss began jet firings to guide Atlantis's journey toward Mir. The crew prepared for the docking by checking out communications equipment and docking and alignment aids. They also activated Spacehab and began orbital operations for Biorack experiments. Godwin and Clifford checked out the space suits and equipment for their upcoming EVA.¹⁴⁹

Atlantis approaches Mir. On mission day 3, when Atlantis was within 8 miles of the station, Chilton fired the orbital maneuvering system engines in the terminal phase initiation (TI) burn. As the two spacecraft completed another orbit, Atlantis approached Mir from below along the R-bar, using rendezvous radar to track its approach rate and measure its distance.¹⁵⁰

March 23-28, 1996

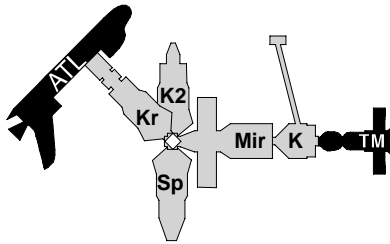

Atlantis

Kristall Kvant 2

- Mir - Kvant - Soyuz-TM 23

Spektr

Third Atlantis/Mir docking. Chilton took manual control at one-half mile below the Mir, executing a 180° yaw rotation to align Atlantis with the Docking Module on Kristall. He used the ODS centerline camera as an aid in refining and maintaining the alignment. At 8:34 p.m. CST on March 23, he achieved contact, adding Atlantis to a space station complex that then totaled 230 t. After confirmation of docking, leak checks, and pressurization of the docking vestibule, the hatches were opened and the two crews greeted each other. Shortly afterward, the Atlantis crew installed ducts to aid in circulating air between the two spacecraft during the docked phase.^{151, 152}

Lucid joins Mir 21 crew. Lucid officially became a Mir 21 crew member at 7:30 a.m. CST on March 24, after a joint "go" from the Russian and U.S. mission control centers. She became the first in a planned continuous U.S. astronaut presence on the station until 1998.¹⁵³

New supplies brought up on Atlantis. In the joint portion of the mission, the two crews loaded into the station more than 1 t of U.S. science equipment, almost 2 t of Russian supplies, and 15 containers of water totaling about 1.5 t. Approximately a ton of excess equipment, waste, and science payload was transferred from Mir to Atlantis.¹⁵⁴ From their vantage point in orbit, the crews were treated to a good view of comet Hyakutake.¹⁵⁵ Some of the spacecraft hardware items brought up by Atlantis were a replacement gyrodyne, a seat liner kit for Lucid to be placed in a Soyuz module if emergency return to Earth was required, and three Russian storage batteries which had been replenished on Earth.¹⁵⁶

Experiment supplies. Some of the new supplies and equipment for onboard experiments included replacement hardware for the Mir glovebox stowage experiments, Mir electric field characterization hardware to measure radio interference inside and around the complex, and a liquid phase sintering experiment that would use the Optizon furnace to bond different metals.¹⁵⁷

Spacehab module work. On flight days 4, 5, and 7, the crew worked on the Biorack in the Spacehab module in the Orbiter payload bay. The Biorack contained eleven experiments to investigate the effects of microgravity and cosmic radiation on plants, animal tissues, bacteria, and insects. The various experiments were designed by France, Germany, the U.S., Switzerland, and the Netherlands.¹⁵⁸

March 23-28, 1996

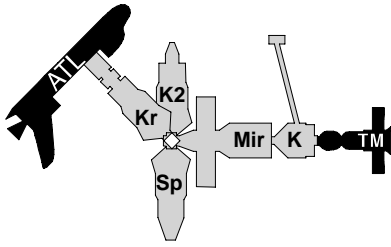

Concluded

Pre-EVA procedures. In preparation for the EVA, Atlantis's cabin air pressure was lowered from 14.7 to 10.2 psi. The hatches were closed between Mir and Atlantis and Atlantis and Spacehab throughout the EVA to allow for sustained cabin depressurization. The Mir crew, including Lucid, stayed inside Mir, and the Atlantis crew stayed inside the Orbiter cabin, with Sega coordinating the space walk activities from inside.¹⁵⁹

SAFER backpacks worn. Attached to their regular portable life support system (PLSS) backpack, Godwin and Clifford donned new self-contained backpacks with propulsion systems to allow enough free-flight capability to return an untethered astronaut to the spacecraft in an emergency. The device, called the simplified aid for EVA rescue (SAFER), was designed for EVAs on docked vehicles which would be unable to quickly retrieve a drifting spacewalker. The backpack was test-flown on STS-64 in September 1994.¹⁶⁰

First EVA by U.S. astronauts at Mir. On March 27, Godwin and Clifford performed their 6-hr EVA in Atlantis's cargo bay and on the exterior of the Mir Docking Module. Their major task was to secure four experiment canisters to handrails on the Docking Module. The experiments, collectively called the Mir Environmental Effects Payload (MEEP), were designed to record data on orbital debris in the environment near Mir, to collect samples of the debris, and to test potential International Space Station materials by exposing them to the low Earth orbit environment. The four passive experiment canisters would be retrieved by a later STS crew after almost 2 years of data collection. During their work on the Docking Module, the astronauts also evaluated new tether hooks and foot restraints that could be used on both Mir and Shuttle Orbiter exteriors, prototypes of International Space Station EVA equipment. They also retrieved the Mir-mounted camera that had been used in docking alignment during STS-74 in November 1995.^{161, 162}

March 28 - April 26, 1996

Kristall Kvant 2

Mir - Kvant - Soyuz-TM 23

Spektr

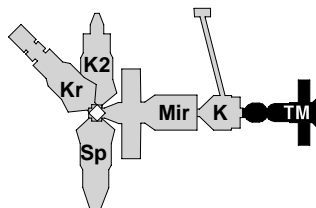

Atlantis leaves Mir again. The STS-76 and Mir 21 crews bid each other farewell on the morning of March 28. They closed the hatches to their spacecraft, and the astronauts began preparations for undocking and return to Earth. With the steering jets to both spacecraft shut down, Atlantis separated from the Mir Docking Module. Then Chilton reactivated the jets and slowly moved away from Mir. At 600 ft out, he began a fly-around, circled the station twice while the crews took pictures of each others' spacecraft, then moved to another orbit.¹⁶³

STS-76 mission ends at Edwards Air Force Base, California.

Weather conditions at Kennedy Space Center in Florida on March 30 were unfavorable for landing, so the crew instead spent an extra day on Earth observation photography. Atlantis landed at Edwards Air Force Base, California, at 7:29 a.m. CST on March 31 after a 9-day, 5-hr mission. However, on a return home interview, Godwin remarked "Our mission won't really be over until [Lucid lands] in August."^{164, 165}

Mir 21 continues with full crew. The daily flight plan, or cyclogram, for the Russian-U.S. crew was provided 4 days ahead of schedule by TsUP. A group of NASA science experts in Moscow served as consultants on science activities. The first week after Atlantis's departure, the crew focused on the Optizon Liquid Phase Sintering Experiment (OLiPSE), processing 70 samples of different metals at high temperatures. The crew also conducted life sciences research and Earth observation photography. Space Acceleration Measurement System (SAMS) monitors were placed throughout the station to record movements that might disrupt experiments. Radiation dosimeters in various locations provided another measurement of the station's internal environment. A leak in a coolant loop in the core module was detected in mid-April, but the crew was unable to find the exact location. That loop was turned off and the alternate loop was used.¹⁶⁶

Priroda on the way to Mir. The long-awaited launch of Priroda, earlier announced for March 10 so that the module would be in place when Lucid arrived at Mir, had been moved forward at least twice—once because of late delivery from the Khrunichev factory, and once because a commercial Proton launch in early April took precedence.¹⁶⁷ But on April 23, Priroda was launched from Baikonur atop an SL-13 Proton rocket for a 3-day orbital trip to Mir. One of the two battery-powered electrical systems on the spacecraft dropped off-line, eliminating the backup power source for the automatic docking system. If the primary electrical system had also malfunctioned, the Mir crew would have immediately initiated a manual docking.¹⁶⁸

Priroda

Specifications

mass-19,700 kg
length-approx. 12 m
max. diameter-4.35 m
pressurized vol.-66 m³

Description

Last of the six permanent habitable Mir modules, Priroda (fig. 11) was, like Spektr, designed by RKK Energia in the mid- to late-1980s, and was built and assembled in the Khrunichev plant between 1989 and 1991, with launch originally planned for 1991 or 1992.

Priroda was designed to carry a deployable solar array, but during launch delays, more solar arrays were planned and designed for addition to other parts of Mir, so the array was not included in the launch configuration.

The module's two propulsion systems included one for orbit correction during the flight to Mir and rendezvous with Mir, and one for berthing and stabilization during the docking phase.¹⁶⁹

All other systems on Priroda, including its Kurs automatic docking system, were powered during the independent flight phase by two redundant sets of large batteries, 168 in all. An electrical connector failure during flight to Mir caused concern over loss of access to the backup set of batteries, but the module docked with no problems. Once the module had been relocated to the +Z port (with its Lyappa arm, also powered by the batteries), the electrical systems were connected to the station's power supply from solar arrays on other modules. The Mir 21 crew bagged the disconnected batteries shortly afterwards and later stowed them in Progress-M 31 for destructive return into Earth's atmosphere.

The Priroda module includes an unpressurized instrument compartment and an instrument/payload compartment, both of which are covered by a payload shroud that protected the module and external equipment from aerodynamic effects during launch.

The unpressurized compartment is mated to the base of the module aft of the instrument/payload compartment, and it extends to partially surround that compartment. It contains propulsion system components, EVA restraints, and scientific equipment. On the opposite end are the docking system and an intravehicular hatch opening into the instrument/payload compartment.

The instrument/payload compartment, the main portion of the module, has an inner habitation and work compartment and an outer instrumentation compartment. The two are separated by aluminum-magnesium coated plastic panels that form a fire break and contribute significantly to the module's environmental control system by allowing conditioned air to flow through the crew's working area before it returns to the instrumentation compartment. The compartment is divided lengthwise into three sections, one that houses spacecraft systems and two that house primarily payload systems and the pressurized working area for the crew.¹⁷⁰

The Priroda mission is to conduct Earth sciences studies through a variety of remote sensing equipment and to develop and verify remote sensing methods. The experiments were designed to not only gather valuable data on land surface, ocean, atmosphere, and ecology, but also to

provide a basis for development of optimal methods of data gathering and analysis and optimal combinations of instruments.¹⁷¹

The experiments, contributed by twelve nations, cover the microwave, visible, near infrared, and infrared spectral regions using both active and passive sounding methods. Active microwave equipment on board is the synthetic aperture radar (SAR), Travers III, to be deployed after docking to Mir.

Passive microwave equipment includes

- Radiometer complexes IKAR-N, consisting of 5 nadir-looking radiometers, and IKAR-D, a four-channel scanning radiometer
- Panorama radiometer complex IKAR-P, a three-channel radiometer and a five-channel radiometer

Optical Instruments are

- Infrared spectrometers ISTOK-1 (Lambda-scanning)(Russia, Czechia): MOS-A and MOS-B, with 17 channels (Germany)
- Spatial high resolution multispectral and stereo scanner MOMS-2P (Germany)
- Conical scanner MSU-SK, 5 channels
- Pushbroom multichannel scanner MSU-E
- A surveying TV camera
- "OZONE-M," for determination of ozone profiles from occultation measurements
- Lidar "Alisa" for active optical sounding (France)

The payload compliment also includes equipment for medical and microgravity experiments, contributed mostly by the United States.¹⁷²

Figure 11. The Priroda module, launched on April 23, 1996, was the last permanent module added to the Mir complex.

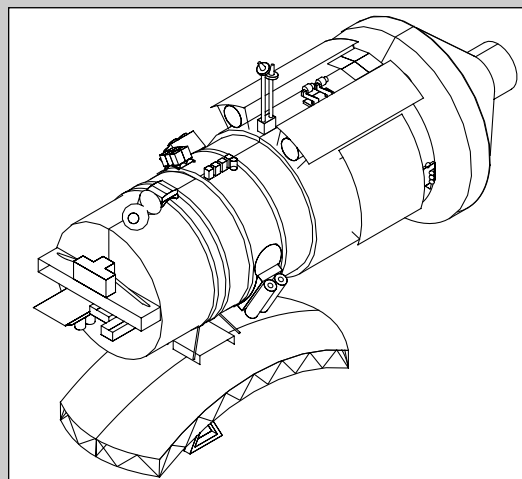

April 26-27, 1996

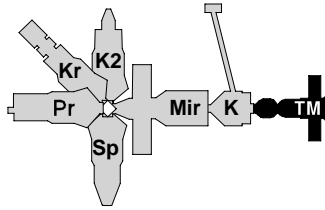

Kristall Kvant 2
Priroda - Mir - Kvant - Soyuz-TM 23
Spektr

Successful docking. The Kurs automatic docking system on Priroda worked flawlessly, as did the electrical system. No problems were encountered on the April 26 docking of the new module at the -X port at the front of the Mir base block.¹⁷³

April 27 - May 7, 1996

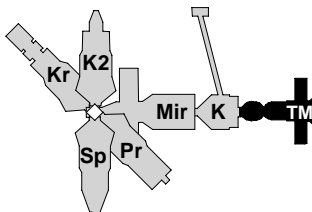

Kristall Kvant 2
Mir - Kvant - Soyuz-TM 23
Spektr Priroda

Priroda at permanent docking spot. On April 27, from inside the station, the Mir 21 crew controlled Priroda's repositioning with the Lyappa arm to the +Z docking port, directly across from the Kristall module.¹⁷⁴ Thus the Mir complex, with its six habitable modules and Docking Module, attained its final basic configuration. Henceforth the shape of the complex would change only temporarily, with dockings by Progress, Soyuz, and Space Shuttle Orbiter vehicles.

Batteries prepared for disposal. Because of concern about possible sulfur dioxide leaks from the malfunctioning battery system, a test of the module's atmosphere was made before the crew entered. Once inside Priroda, the crew's first task was to unbolt the batteries, cap their connectors, and place them in plastic bags—again because of possible sulfur dioxide leakage. The 168 batteries would later be placed in Progress-M 31 for disposal. The crew began connecting Mir power sources to Priroda systems and troubleshooting the battery system problem.¹⁷⁵

May 7 - August 1, 1996

Kristall Kvant 2
Progress-M 31 - Mir - Kvant - Soyuz-TM 23
Spektr Priroda

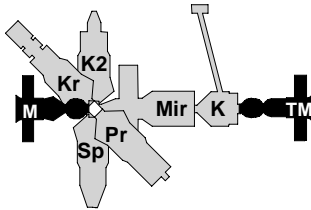

Progress M-31 brings new supplies. A new Progress cargo spacecraft was launched from Baikonur on May 5 and docked under control of the Kurs automatic system at the -X port of Mir on May 7 (fig. 12). For the first time in the station's history, all ports of the base block were occupied at the same time. The crew began unloading the vehicle that week, in addition to continuing their science experiments and Priroda activation. They successfully tested the new Mir interface-to-payload systems (MIPS) hardware for downlinking data to the ground and replaced three nickel-cadmium batteries in the Priroda power system. However, a power controller for the system failed, and ground controllers began monitoring and controlling battery charging. The crew finally isolated the coolant loop leak in the core module, but there was no health risk associated with the leak, and repair was not immediately scheduled.¹⁷⁶

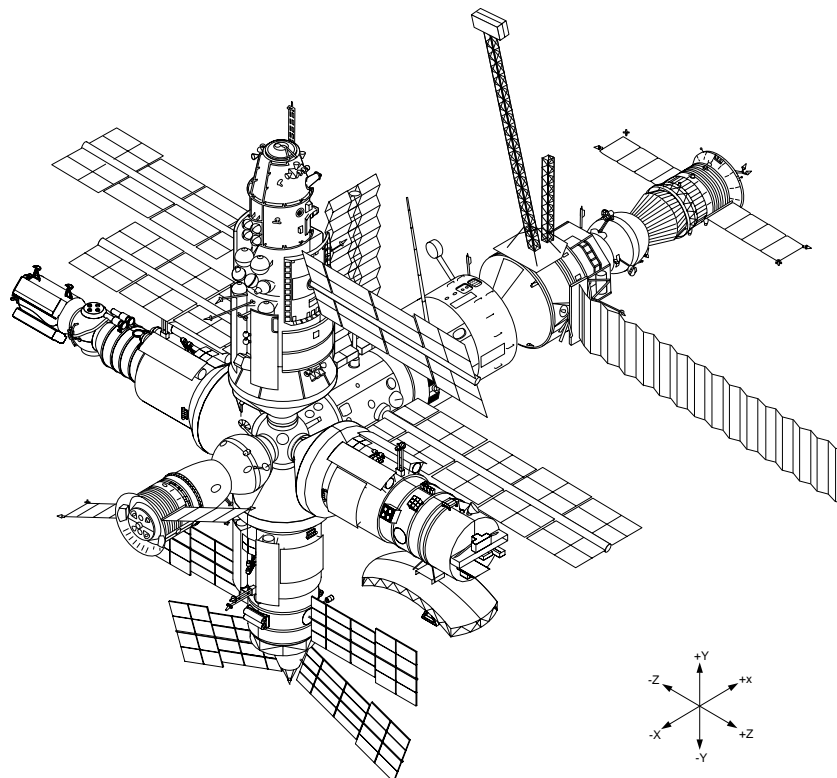

5-7-96 Configuration

Figure 12. The Mir complex on May 7, 1996, with all base block ports occupied. Priroda had docked with the station initially on April 26 and subsequently had been relocated to the +Z port. Progress-M 31 docked at the -X port to complete the configuration.

May 7 - August 1, 1996

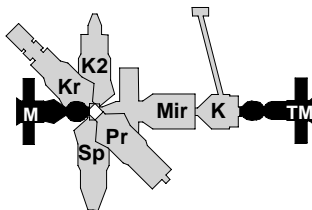

Continued

Cooperative Solar Array installed during Mir 21 crew's second and third EVAs. Onufrienko and Usachev left the station early on May 20 to remove the Mir Cooperative Solar Array from its stowed position on the exterior of the Docking Module at the base of Kristall. They used the new Strela boom installed during their March 15 EVA to reach the array and move it to the Kvant module, where they positioned its cables in preparation for final installation during their next EVA. During the 5-hr, 20-min EVA, they inflated an aluminum and nylon model of a Pepsi Cola can, which they filmed against the backdrop of Earth. The soft drink company paid for the procedure and planned to use the film in a television commercial.^{177, 178, 179} On May 25, in their third space walk of the mission, the cosmonauts were outside the station for 5 hr, 43 min, completing the solar array installation on Kvant. After all connections were made, the array unfurled upon command from inside the station.¹⁸⁰

Mir 21 crew greets STS-77 crew. As the cosmonauts prepared for yet another space walk, Lucid continued testing and activating U.S. equipment in Priroda and Spektr. She also conducted materials experiments, including two runs of the Liquid Diffusion-II payload to study molten metals in space. All the crew members exchanged greetings with the astronauts aboard Endeavour on Shuttle mission STS-77 and held a conference with U.S. and Russian news media.

Camera installed on Priroda exterior during fourth Mir 21 EVA. On May 30, Onufrienko and Usachev installed the Modular Optoelectronic Multispectral Scanner (MOMS), a German remote sensing camera, on the Priroda module. The camera, designed to collect Earth atmosphere and environment data, had been flown earlier on two Shuttle missions, STS-7 in June 1983 and STS-41B in February 1984. After the installation, Lucid activated the system by remote command from inside the station. During the 5-hr EVA, the cosmonauts also installed a new handrail on Kvant-2 to facilitate movements in future space walks.¹⁸¹

More experiments installed during fifth EVA. The Particle Impact Experiment and the Mir Sample Return Experiment, U.S. space science experiments brought to orbit inside Priroda, were installed on the exterior of Kvant 2 during a June 6 EVA lasting about 3.5 hr. The cosmonauts also replaced a cassette in the Komza experiment on the surface of Spektr.^{182, 183}

Rapana girder assembled on Kvant in sixth EVA. On June 13, the cosmonauts spent over 5 hr outside Mir, installing and deploying a Rapana girder on the surface of the Kvant module as a platform for installing future experiments on the station exterior. The 5-m structure was deployed in four sections. Another activity during this EVA was manual deployment of the Travers radar antenna on the exterior of Priroda. The large antenna had failed to deploy fully by commands from inside the station.^{184, 185}

May 7 - August 1, 1996

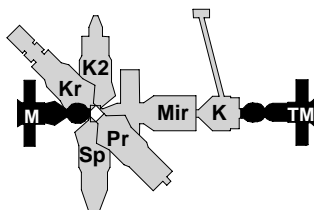

Concluded

Science work continues. In addition to assisting the cosmonauts during EVAs from inside the station, Lucid continued activating equipment, such as the Biotechnology System Facility for long-term biotechnology studies, and conducting experiments such as the Humoral Immunity experiment to study spaceflight effects on the human immune system. The crew also monitored various aspects of the spacecraft environment. They took air samples in Spektr and the core module using the Solid Sorbent Air Sampler (SSAS) and the Grab Sample Container (GSC). They recorded effects of spacecraft motion with the SAMS equipment and began evaluation of the Microgravity Isolation Mount (MIM).¹⁸⁶

Fourth Shuttle docking with Mir delayed. On July 12, NASA announced the decision to postpone the July 31 launch of the STS-79 mission, in which Atlantis was to dock with Mir for the fourth time, until mid-September. In the interim, NASA planned to replace the solid rocket boosters to be used in the launch because of a postflight discovery that hot gas had seeped into the joints of the boosters used in STS-78 launch in June. In spots the gas penetrated the J-joints to, but not past, the capture feature O-rings. An investigation revealed that the most probable cause of the leakage was use of a new adhesive and cleaning fluid, also used on the boosters for STS-79. Although the boosters were judged safe to fly, a decision was made to replace them in order further study the J-joint failure and to improve the safety margin of the joint.

U.S. record surpassed and counting. On July 15, Lucid surpassed the space duration record for a U.S. astronaut, set by Norm Thagard with his 115 days on Mir Principal Expedition 18 in 1995. With the delay of STS-79, her flight record would be even longer than originally anticipated.

Greenhouse work. The crew assembled the Svet facility for the Fundamental Biology Greenhouse plant experiment during the latter part of July. A temporary limitation of power in Kristall caused a delay in the first planting, but was solved when ground planners instructed the crew to plug an extension cord into Spektr's power supply. Station maintenance during the last week of July included replacement of a vacuum valve assembly on the carbon dioxide removal system. On July 26, the oxygen generation system began sporadic malfunctioning. The crew activated the backup oxygen system on August 1.¹⁸⁷

August 1-2, 1996

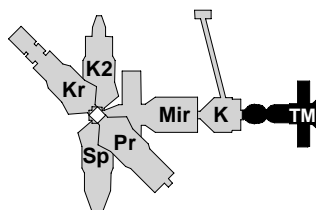

Kristall Kvant 2
- Mir - Kvant - Soyuz-TM 23
Spektr Priroda

Progress-M 31 departs. On August 1, at 16:45 UTC, Progress-M 31 left the -X port for destructive reentry into Earth's atmosphere.

August 2-18, 1996

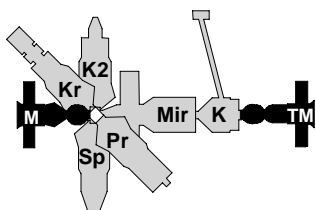

Kristall Kvant 2
Progress-M 32 - Mir - Kvant - Soyuz-TM 23
Spektr Priroda

And Progress-M 32 arrives. Launched on July 31 with fresh supplies and hardware for the upcoming Cassiopee mission experiments, Progress-M 32 docked at the -X port on August 2.

Gyrodynes refurbished. The Mir 21 crew began setting up experiments for the upcoming mission. They also refurbished the gyrodyne system, maintaining station attitude by thruster firings August 5-7 while the gyrodynes were not available.

August experiment work. The seeds for the first crop of dwarf wheat were planted in the Greenhouse on August 5. Earth observations were made of areas of the United States, Europe, and Asia. Lucid continued to run experiments, including

- Queen's University Experiment in Liquid Diffusion (QUELD), using a furnace to analyze the formation of alloys in space. To record the effects of the furnace experiment, she took SAMS data and Enhanced Dynamic Load Sensors (EDLS) data.
- Candle Flame in Microgravity (CFM), to study the physiochemical processes of combustion. She reported that the appearance of flame in microgravity was quite different from that on Earth.
- Anticipatory Postural Activity (POSA) experiment, to measure how muscles work in microgravity, for use in studies of physiological adaptations to spaceflight.
- Forced Flow Framespread test, to examine the flame-spreading properties of solid fuels.
- Solid Sorbent Air Sampler for Volatile Organic Compounds, to evaluate the Mir environment and provide data for development of advanced life support systems.
- Tissue Equivalent Proportional Counter (TEPC), a radiation-dosage measurement device.¹⁸⁸

Life on Mars? The crew was excited when they received news from the ground about NASA's August 6 announcement of the evidence of primitive life forms in a Martian meteorite found in

August 2-18, 1996

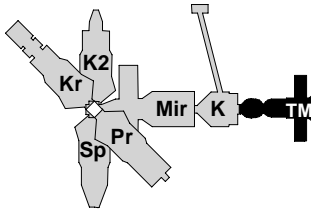

Concluded

Antarctica. Lucid said in a television interview on August 12 that she and her crew mates were enthusiastic about the idea of human flights to Mars.

Soyuz-TM 24 launched. On August 17, Soyuz-TM 24 was launched from Baikonur with the new crew for Mir Principal Expedition 22.

August 18-19, 1996

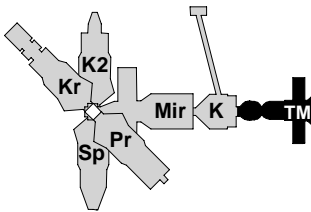

Kristall Kvant 2

Mir - Kvant - Soyuz-TM 23

Spektr Priroda

Progress-M 32 bows out. To free the -X port for docking of the approaching Soyuz-TM 24, the Progress module was undocked on August 18 under automatic control and moved to a parking orbit. There it would remain until the departure of Soyuz-TM 23 with the homeward-bound Mir 21 crew on Sept 2.

**August 19 -
September 2, 1996**

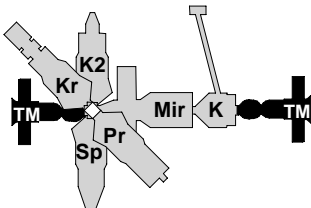

Kristall Kvant 2

Soyuz-TM 24 - Mir - Kvant - Soyuz-TM 23

Spektr Priroda

Mir 22 crew arrives. Soyuz-TM 24 docked at the -X port on August 19. New arrivals were Mir 22 Commander Valery Korzun and Flight Engineer Alexander Kaleri. Visiting French Space Agency (CNES) Cosmonaut Researcher Claudie Andre-Deshays accompanied them to Mir for a 2-week program of a scientific investigations collectively called Cassiopee. She would return to Earth with the Mir 21 crew. (A few days before the launch of Soyuz-TM 24, the commander of the Mir 22 primary crew, Gennady Manakov, had been grounded because of possible heart problems. Flight Engineer Pavel Vinogradov would also have to forego Mir 22 because the two had trained together.)

Multinational activities. Once again, three nations were represented on Mir. Cassiopee, the fifth CNES-RSA joint mission, would be under the cooperative control of TsUP in Moscow and CADMOS in France.

Cassiopee mission. Andre-Deshays, Korzun, and Kaleri worked on the following experiments:

- PHYSIOLAB, a study of cardiovascular physiology using LBNP devices

**August 19 -
September 2, 1996**

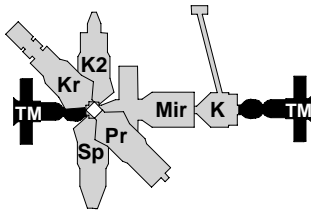

Concluded

- COGNILAB, tests of neurosensory system responses in microgravity
- FERTILE, egg-based studies to determine the role of gravity in embryonic development
- ALICE II, experiments in fluid dynamics (hydrodynamic and thermal properties of fluids at critical point)
- CASTOR, analyses of structural dynamics in space using
 - DYNLAB, to measure the vibrations in the Mir modules
 - TREILLIS, a 2-m-long metallic trellis, to validate mathematical simulations of structural damping modes ¹⁸⁹

Mir 21 Closeout. The Mir 21 crew continued preparations for departure, packing items for return to Earth and handing over responsibilities to the new crew. Lucid, who would remain on the station until the arrival of Atlantis on STS-79 in mid-September, also monitored continuing experiments. She reported that the dwarf wheat crop was about 2 in. tall 3 weeks after planting.

September 2-3, 1996

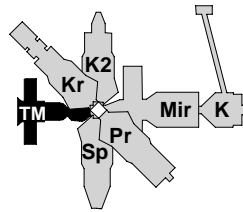

**Kristall Kvant 2
Soyuz-TM 24 - Mir - Kvant
Spektr Priroda**

Mir 21 crew goes home. Onufrienko, Usachev, and Andre-Deshays departed Mir on September 2 in the Soyuz-TM 23 spacecraft and safely landed in Central Asia. Onufrienko and Usachev had been in space 194 days, Andre-Deshays 17 days.

September 3-18, 1996

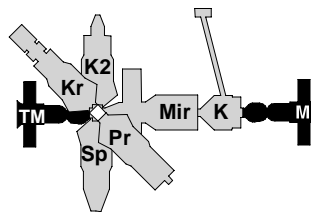

**Kristall Kvant 2
Soyuz-TM 24 - Mir - Kvant - Progress-M 32
Spektr Priroda**

Progress-M 32 redocks. A day later, September 3, Progress-M 32, which had been in a parking orbit for 2 weeks after it undocked from the -X port to make way for Soyuz-TM 24, successfully redocked at the +X port. This configuration would remain until the September 18 docking of Atlantis with Mir, during which John Blaha would replace Lucid as the U.S. astronaut aboard the station.

Appendix

Comparative Chronology of U. S. and Russian Human Space Missions from November 1994 through August 1996

This list of Russian and U.S. human missions is provided for quick reference. It also includes flights of the Russian Progress-M cargo vehicles which, although they did not actually transport humans, ferried supplies for humans on Mir missions. Launch to landing dates are shown at left; mission descriptions are on the right. Dates of dockings and other notable milestones within a mission are included in the description column. Russian missions are indicated by bold dates and names, U. S. missions by underlining, and joint Russian-U.S. missions by italics.

Date	Mission
October 3, 1994-March 22, 1996	Mir Principle Expedition 17. Crew: Commander Alexandr Viktorenko, Flight Engineer Yelena Kondakova, and cosmonaut Valeri Polyakov, who set a new record for human space flight duration with his 438-day stay. Mir 17 hosted Euromir 94, first ESA mission aboard Mir. Space Shuttle Atlantis rendezvoused with Mir on its STS-63 mission.
<u>November 3-14, 1994</u>	<u>STS-66.</u> Crew: Commander Donald R. McMonagle, Pilot Curtis L. Brown, Jr., Payload Commander Ellen Ochoa, Mission Specialists Scott E. Parazynski, Joseph R. Tanner, Jean-Francois Clervoy (ESA astronaut). Part of NASA's Mission to Planet Earth, the flight had an international crew and experiments provided by several nations. The Atmospheric Laboratory for Applications and Sciences-03 (ATLAS-03), the primary payload, was flown to study the energy of the sun and how it affects the Earth's climate and environment.
November 11, 1994-February 16, 1995	Progress M-25 docked with Mir on November 13 with crew supplies and repair parts.
<i>February 3-10, 1995</i>	<i>STS-63.</i> U.S. Space Shuttle Orbiter Discovery rendezvoused with Mir from February 6 through 8. Crew members were Commander James D. Wetherbee, Pilots Eileen M. Collins and Michael Foale, Mission Specialists Janice E. Voss and Bernard A. Harris, Jr., and Russian cosmonaut Vladimir G. Titov. Primary objectives were to verify flight techniques and interfaces between communications and navigation equipment, and to study Shuttle Orbiter/Mir proximity operations in preparation for the STS-71 docking mission. An EVA during which two astronauts manipulated the Spartan-204 free-flying retrievable platform provided experience with manipulating large objects in space.

February 15-March 15, 1995

Progress-M 26, with a cargo that included equipment for experiments on the Mir 18 mission, docked with Mir on February 17.

March 2-18, 1995

STS-67. Endeavor set a Space Shuttle Orbiter record of 16 days, 15 hours in space. The primary payload was Astro-2, a suite of three instruments flown on Spacelab for astronomical observations in the ultraviolet spectrum. Crew: Commander Stephen S. Oswald, Pilot William G. Gregory, Payload Commander Tamara E. Jernigan (3) , Mission Specialists John M. Grunsfeld and Wendy B. Lawrence, Payload Specialists Ronald A. Parise and Samuel Durrance.

March 14-July 7, 1995

Mir Principle Expedition 18. Crew: Commander Vladimir Dezhurov, flight engineer Gennadiy Strekalov, Cosmonaut-Researcher Norman Thagard (U.S. astronaut). Joint U.S.-Russian medical research and weightlessness effects investigations were conducted and the station was reconfigured for the arrivals of the Spektr science module and the Space Shuttle Atlantis. Notable "firsts" were the addition of the first new module (Spektr) since Kristall arrived in 1990, the first American (Thagard) to be part of a Mir crew, and the first docking of a U.S. spacecraft (Atlantis on STS-71) with the Mir complex. The crew returned to Earth on Atlantis.

March 14-September 11, 1995

Soyuz-TM 21, carrying the Mir 18 crew, docked with Mir on March 16. Because Atlantis took that crew home and brought up the next crew on STS-71, Soyuz-TM 21 did not return to Earth until the end of the 19th Principle Expedition. From March 14-18, the thirteen space travelers aboard Mir (crews 17 and 18) and Endeavor set a record for number of humans in orbit at one time.

March 22, 1995

Soyuz-TM 20, which had been launched October 3, 1994, to deliver the Principle Expedition 17 crew to Mir, returned that crew to Earth. Physician Valeri Polyakov, who went up on January 8, 1994 with the Mir 15 crew, had attained a record 438 days in space.

April 9-May 23, 1995

Progress-M 27 docked at Mir with supplies on April 11.

May 20, 1995

Spektr, launched by a Proton-K rocket on May 20, docked with Mir's -X port on June 1 and was relocated to the -Y port on June 2. Spektr was the first new module to be added to Mir since 1990, bringing the total to five permanent habitable modules.

June 27-July 7, 1995

STS-71. Atlantis docked with Mir, the first U.S. Space Shuttle Orbiter to do so, and the first U.S. craft to dock with a Russian one since the Apollo-Soyuz mission on July 17, 1975. A new Orbiter Docking System had been installed in the payload bay for the docking with Kristall's APAS system. The U.S. crew members were Commander Robert L. Gibson, Pilot Charles J. Precourt, Mission Specialists Ellen S. Baker, Bonnie J. Dunbar, and Gregory J. Harbaugh. The ascending crew included that of Mir 19 Commander Anatoly Solovyev and Flight Engineer Nikolai Budarin. The descending crew included Mir 18 Commander Vladimir Dezhurov, Flight Engineer Gennadiy Strekalov, and (American) Cosmonaut Researcher Norm Thagard. During the 5-day docking, June 29-July 4, the 10 members of the combined crews set a record for the most humans aboard a single space complex at the same time. This was the 100th Space Shuttle Orbiter flight.

June 27-September 11, 1995

Mir Principle Expedition 19. Commander Anatoly Solovyev and flight engineer Nikolai Budarin were the first Mir crew launched on a Space Shuttle Orbiter. They began their work on Mir in conjunction with a visiting U.S. crew and a departing international crew and ended their stay by welcoming an incoming international crew. Two of their EVAs involved deployment and retrieval of international experiments.

July 13-22, 1995

STS-70. The Discovery astronauts deployed a Tracking and Data Relay Satellite (TDRS-G) completing world-wide coverage for the TDRS ground-to-satellite communications network, which is one of NASA's means of contacting the shuttles. Crew members were Commander Terence T. Henricks, Pilot Kevin R. Kregel, Mission Specialists Nancy Jane Currie, Donald A. Thomas, and Mary Ellen Weber.

July 20-September 4, 1995

Progress-M 28 docked with Mir on July 22 to resupply the station and provide ESA equipment for the Euromir 95 (Mir 20) mission.

September 3, 1995-February 29, 1996

Mir Principle Expedition 20. Soyuz-TM 22 docked with Mir on September 5, carrying the Mir 20/Euromir 95 international crew: Commander Yuriy Gidzenko, Flight Engineer Sergey Avdeyev, and ESA Cosmonaut Researcher/Flight Engineer Thomas Reiter. The crew returned in the same Soyuz-TM, 44 days later than originally scheduled. During the Mir 20 mission, Atlantis docked with the station on STS-74. Euromir 95 included studies of microgravity effects on the human body and materials processing experiments.

September 7-18, 1995

STS-69. Crew: Commander David M. Walker, Pilot Kenneth D. Cockrell, Payload Commander James S. Voss, Mission Specialists James H. Newman and Michael L. Gernhardt. Two free-flying experiments, the Wake Shield Facility and the Spartan 201 astronomy satellite, were released into orbit and retrieved before mission end.

October 8-December 19, 1995

Progress-M 29 docked with Mir on October 10. Its cargo included additional equipment for the extended Euromir 95 mission.

October 20-November 5, 1995

STS-73 was the second Microgravity Laboratory flight (USML-2). Other payloads aboard Columbia included the Orbital Acceleration Research Experiment (OARE) and the Midcourse Space Experiments (MSX). Crew: Commander Kenneth D. Bowersox, Pilot Kent Rominger, Payload Commander Kathryn Thornton, Mission Specialists Catherine Coleman and Michael Lopez-Alegria, Payload Specialists Fred Leslie and Albert Sacco.

November 12-20, 1995

STS-74. On its second docking with Mir, Atlantis delivered the Russian-built Docking Module, which was installed on Kristall for use in future Shuttle dockings. Two new solar arrays were stowed on the exterior of the Docking Module for deployment later. Crew members were Commander Kenneth D. Cameron, Pilot James D. Halsell, Mission Specialists Jerry L. Ross, William S. McArthur, and Canadian Chris A. Hadfield.

December 18, 1995-February 22, 1996

Progress-M 30 docked with Mir on December 30.

February 21-September 2, 1996

Mir Principle Expedition 21. Soyuz-TM 23 docked with Mir on February 23, delivering the two Russian members of the Mir 21 crew, Commander Yuri Onufrienko and Flight Engineer Yuri Usachev. Cosmonaut Researcher Shannon Lucid (U.S. astronaut) joined them on March 22 after Atlantis docked with Mir a third time, during the STS-76 mission. The last permanent module, Priroda, was added to the complex in April.

February 22-March 9, 1996

STS-75. Columbia featured reflight of the Italian Tethered Satellite System (TSS-1R). Although the tether was deployed successfully, it broke as it neared the end of its planned 12.8 mile distance.

The international crew included ESA Mission Specialists Maurizio Cheli and Claude Nicollier, and Italian Payload Specialist Umberto Guidoni. U.S. crew members were Commander Andrew M. Allen,

- Pilot Scott J. Horowitz, Payload Commander Franklin R. Chang-Diaz, and Mission Specialist Jeffrey A. Hoffman.
- March 22-31, 1996*
- STS-76.* In its third U.S. Shuttle docking mission with Mir, Atlantis delivered the third Mir 21 crew member, U.S. astronaut Shannon Lucid. Other STS-76 crew members were Commander Kevin Chilton, Pilot Rick Searfoss, Payload Commander Ron Sega, Mission Specialists Rich Clifford and Linda Godwin. During the March 23-28 docking phase, Godwin and Clifford installed the Mir Environmental Effects Payload (MEEP) on the Docking Module in the first Mir EVA by U.S. astronauts.
- April 23, 1996**
- Priroda** docked flawlessly with Mir on April 26 despite concern about the battery-powered electrical system. The module, devoted primarily to Earth resources investigations, is the sixth (and last) permanent habitable Mir module.
- May 5-Aug. 1, 1996**
- Progress-M 31** docked with Mir on May 7.
- May 19-29, 1996
- STS-77. Endeavour flew microgravity research experiments aboard the Spacehab module and deployed and retrieved the Spartan-207/IAE (Inflatable Antenna Experiment) satellite. Crew: Commander John H. Casper, Pilot Curtis L. Brown Jr., Mission specialists Daniel W. Bursch, Mario Runco, Jr., Canadian Marc Garneau, and Andrew S. W. Thomas.
- June 20-July 7, 1996
- STS-78. Endeavour's flight of the Life and Microgravity Spacelab (LMS) mission set a new U.S. Space Shuttle endurance record with its duration of 16 days, 21 hours, 47 minutes. Crew: Commander Terence T. Henricks, Pilot Kevin R. Kregel, Flight Engineer, Susan J. Helms, Mission Specialists Richard M. Linnehan, Charles E. Brady, Jr., Payload Specialists Jean-Jacques Favier (France) and Robert Brent Thirsk (Canada).
- July 31, 1996-**
- Progress-M 32** docked with Mir August 2. The module was undocked from the -X port under automatic control on August 18 to make room for Soyuz-TM 24. It was placed in a parking orbit until the departure of Soyuz-TM 23, at which time it was redocked at the +X port.
- August 17, 1996-**
- Soyuz-TM 24** arrived at Mir on August 19 with the Mir 21 crew, Commander Valery Korzun and Flight Engineer Alexander Kaleri, and visiting French cosmonaut-researcher Claudie Andre-Deshays.

References

1. Neville Kidger, "Mir Space Station Update," *Spaceflight*, v. 37, March 1995, p. 99.
2. *Space Calendar*, Jan. 9-15 and Jan. 23-29, 1995.
3. David S. F. Portree, "Mir Hardware Heritage," NASA RP-1357, 1995, p. 117.
4. Portree, "Heritage," p. 146-147.
5. Kidger, "Mir...Update," p. 99.
6. Chris van den Berg, "MirNews" 242, Jan. 26, 1995.
7. NASA Public Affairs Office, STS-63 Mission Report.
8. William Harwood, "Thruster Problem Prompts Team Integration," *Space News*, Feb. 13-19, 1995.
9. *Space Calendar*, Jan. 30-Feb. 5, 1995.
10. Portree, "Heritage," p. 194.
11. NASA Kennedy Space Center, STS-63 Mission Highlights at (<http://www.ksc.nasa.gov/shuttle/missions/sts-63/mission-sts-63.html>).
12. Harwood, "Thruster Problem...."
13. Peter B. de Selding, "Shuttle-Mir Dockings Pose Logistics Problems," *Space News*, Feb. 20-27, 1995.
14. NASA KSC, STS-63 Mission Highlights.
15. *Space News*, Feb. 13-19, 1995.
16. Ben Iannotta, "Station Engineers Study Mir's Telltale Scars from Debris," *Space News*, March 22-April 2, 1995, p. 10.
17. Roelof Schuiling, "EVAs Follow Mir Rendezvous," *Spaceflight*, v. 37, May 1995, p. 155.
18. NASA KSC, STS-63 Mission Highlights.
19. van den Berg, "MirNews" 244, Feb. 12, 1995.
20. *Ibid.*
21. *Ibid.*
22. *Space Calendar*, Feb. 20-26, 1995.
23. Kaliningrad Mission Control Center, Mir 18 Status Report 1, March 14, 1995.
24. van den Berg, "MirNews" 247, March 16, 1995.
25. Kaliningrad MCC, Mir 18 Status Report 3, March 16, 1995.
26. William Harwood, "Thagard Joins Mir Cosmonauts," *Space News*, March 30-April 5, 1995.
27. Kaliningrad MCC, Mir 18 Status Report 4, March 17, 1995.
28. Neville Kidger, "Thagard Joins Cosmonauts," *Spaceflight*, v. 37, June 95, p. 190.
29. Neville Kidger, "Mir Docking Plans Meet with Success," *Spaceflight*, v. 37, July 95, p. 221.
30. Kaliningrad MCC, Mir 18 Status Reports 7 and 8, March 28 and 31, 1995.
31. Kidger, "Mir Docking Plans...", p. 222.
32. Kidger, "Mir Docking Plans...", p. 223.
33. *Ibid.*
34. van den Berg, "MirNews" 249, 250, 251—April 6, 12, 20, 1995.
35. van den Berg, "MirNews" 249, April 6, 1995.

36. NASA PAO, Mir 18 Mission Science Reports, April 19-25, 1995.
37. Kidger, "Mir Docking Plans....," p. 223.
38. NASA PAO, Mir 18 Mission Science Report, May 4, 1995.
39. van den Berg, "MirNews" 253 and 254, May 15 and 16, 1995.
40. Kaliningrad MCC, Mir 18 Status Report 20, May 12, 1995.
41. van den Berg, "MirNews" 255 and 256, May 17 and 18, 1995).
42. Craig Covault, "EVA Problems Delay Mir Station Changes," Aviation Week & Space Technology, v. 142, May 22, 1995, p. 65.
43. Kidger, "Mir Docking Plans....," p. 223.
44. Kidger, "Mir Docking Plans....," p. 224.
45. NASA PAO, Mir 18 Mission Science Report, May 22 and May 24, 1995.
46. Kidger, "Mir Docking Plans....," p. 224.
47. van den Berg, "MirNews" 259, May 26, 1995.
48. Kidger, "Mir Docking Plans....," p. 224.
49. Anser Center for International Aerospace Cooperation, Moscow Office Report 133, May 26, 1995.
50. Nicholas L. Johnson, The Soviet Year in Space, 1990. Colorado Springs, Colorado, Teledyne Brown Engineering, 1991, p. 98.
51. Mir Extension Assessment Team, "MEAT Mir Diagrams to Facilitate Joint Technical Discussions, Vol. I: Modules and Vehicles," [Johnson Space Center], Feb. 1996.
52. Kidger, "Euromir 95," Spaceflight, v. 37, Dec. 1995, p. 404.
53. L. Van den Ableen, "A Mir Matter of Change," Spaceflight, v. 37, Aug. 1995, p. 293.
54. "Spektr Module Soon to Augment Mir Station," 957A0681B SEGODNYA, 4/27/95 p. 9; translated in JPRS Report, Space Science and Engineering, FBIS-UST-95-030, p. 20.
55. NASA PAO, Internet Shuttle/Mir page.
56. Anser CIAC, "Moscow Office Report" 158, Nov. 10, 1995.
57. Kidger, "Mir Docking Plans....," p. 225.
58. Kaliningrad MCC, Mir 18 Mission Status Report 28, June 9, 1995.
59. Kidger, "Mir Docking Plans," p. 225.
60. Kaliningrad MCC, Mir 18 Mission Status Report 28, June 9, 1995.
61. Kidger, "Historic....," p. 274.
62. van den Berg, "MirNews" 264, June 17, 1995.
63. Kidger, "Historic....," p. 274.
64. NASA Advisory Council Task Force on the Shuttle-Mir Rendezvous and Docking Missions, Fifth Report, Sept. 21, 1995, part 2, p. 6.
65. Kaliningrad MCC, Mir 18 Status Report 31, June 20, 1995.
66. Portree, "Heritage," p. 34.
67. Neville Kidger, "Development of the Orbiter Docking system," Spaceflight v. 37 June 1995, p. 188.
68. Neville Kidger, "STS-71 Docking Plans," Spaceflight, v. 37, June 1995, p. 187.
69. Portree, "Heritage," p. 166.
70. James R. Asker, "Shuttle Docking System Performs Many Tasks," Aviation Week and Space Technology, v. 143, July 3, 1995, p. 21.

71. Kidger, "Historic...", p. 275.
72. STS-71 Mission Control Center Reports, NASA STS-71 homepage, MCC Status Reports 1, 2, & 3, June 27-28, 1995.
73. James T. McKenna, "Atlantis Mission Verifies Mir Rendezvous Scheme," *Aviation Week & Space Technology*, Nov. 21, 1994, p. 101.
74. Kidger, "Historic...", p.275.
75. STS-71MCC Status Report 4, June 29, 1995.
76. Kidger, "Historic...", pp.276-277.
77. STS-71 MCC Status Reports 5 and 6, June 29-30, 1995.
78. Kidger, "Historic...", pp. 276-277.
79. STS-71 MCC Status Reports 7 and 8, June 30-31, 1995.
80. Kidger, "Historic...", p. 277.
81. Roelof L. Schuiling, "First Docking Mission," *Spaceflight*, v. 37, Oct. 1995, p. 333.
82. Ben Huset, "Mirwatch," Aug. 1995.
83. James T. McKenna, "Joint Flight Proves Shuttle-Mir Plans," *Aviation Week & Space Technology*, July 10, 1995, p. 22.
84. STS-71 MCC Status Reports 16, 18, 20, July 5, 6, 7, 1995.
85. NASA Advisory Council Task Force on the Shuttle-Mir Rendezvous and Docking Missions, Fifth Report, Sept. 21, 1995, part 2, p. 6.
86. van den Berg, "MirNews" 266, July 17, 1995.
87. Neville Kidger, "Three EVAs for Mir Duo," *Spaceflight*, v. 37, Sept. 95, p. 311.
88. Ibid.
89. van den Berg, "MirNews" 266, July 17, 1995.
90. Kidger, "Three EVAs...", p. 311.
91. Craig Covault, "EVAs, Station Changes Keep Cosmonauts Busy," *Aviation Week and Space Technology*, July 24, pp. 62-63.
92. Kidger, "Three EVAs...", p. 311.
93. van den Berg, "MirNews" 268, July 22, 1995.
94. *Space Calendar*, Aug. 28-Sept 3, 1995.
95. van den Berg, "MirNews" 269, Aug. 26, 1995.
96. Kidger, "Euromir 95," p. 404.
97. ESA Press Release 23-95, Paris, Sept. 4, 1995.
98. Roelof L. Schuiling, "First Docking Mission," *Spaceflight*, v. 37, Oct. 1995, p. 335.
99. van den Berg, "MirNews" 272, Sept 11, 1995.
100. "ESA Astronaut Selected for Euromir 95," *Spaceflight*, v. 37, May 1995, p. 175.
101. Kidger, "Euromir 95," p. 403.
102. Anser CIAC, Moscow Office Report 155, Oct. 20, 1995.
103. ESA Press Releases 18-95, 42-95, and 43-95.
104. Huset, "Mirwatch," Nov. 1995.
105. Peter B. de Selding, "ESA, Russia Discuss Mir Mission Extension," *Space News*, v. 6, no. 40, Oct. 16-22, 1995.
106. ESA Press Release 42-95.
107. Kidger, "Euromir 95," p. 404.

108. ESA Press Releases 18-95, 42-95, and 08-96.
109. Huset, "Mirwatch," Nov. 1995.
110. Craig Covault, "Mir Crew Repairs Air Scrubbing System," *Aviation Week and Space Technology*, V. 143, Nov.6, 1995, p. 27.
111. Huset, "Mirwatch ," Nov., Dec., 1995.
112. Peter B. de Selding, "Mir Cosmonauts Testing Air Cleaner that Uses Microbes to Convert Gases," *Space News*, v. 6, no. 43, Nov. 6-12, 1995.
113. NASA Public Affairs Office, STS-74 Press Kit.
114. Roelof L. Schuiling, "Module for Mir," *Spaceflight*, v. 38, Jan 1996, p. 5.
115. William Harwood, "Canadian Astronaut to Erect Docking Module on Mir," *Space News* v. 6, no. 43, Nov. 6-12, 1995.
116. Dennis Newkirk, "New Module for Mir, *Spaceflight*," v. 37, Nov.1995, p. 369.
117. Portree, "Heritage," p. 166.
118. NASA PAO, STS-74 Press Kit, "Orbiter Docking System."
119. NASA PAO, STS-74 Press Kit, "Mission Summary."
120. Roelof Schuiling, "Second Shuttle Docking with Mir," *Spaceflight* ,v. 38, March 96, pp. 90-91.
121. NASA PAO, STS-74 Press Kit, "Mir Cooperative Solar Array Program."
122. Friends and Partners in Space homepage, MSCA description by Gabriel R. Katell.
123. James R. Asker, "Atlantis Passes First Space Station Assembly Test," *Aviation Week and Space Technology*, v. 143, Nov. 20, 1995, p. 91.
124. Roelof Schuiling, "Second Shuttle Docking....," p. 90.
125. Ibid.
126. Asker, "Atlantis Passes....," pp. 90.-91.
127. James R. Asker, "Module Delivery Offers Mir Image of New Station," *Aviation Week and Space Technology*, Dec. 11, 1995, pp. 60-61.
128. NASA PAO, STS-74 Press Kit.
129. Asker, "Atlantis Passes....," pp. 90-91.
130. Neville Kidger, "Mir Highlights," *Spaceflight*, v. 38, March 1996, p. 93.
131. Ibid.
132. Theo Pirard, "Art Exhibition in Space." *Spaceflight*, v. 38, Feb. 1996, p.64.
133. Kidger, "Highlights," p. 93.
134. Ibid.
135. Neville Kidger, "Science Tasks and EVA for Crew," *Spaceflight*, v. 38, April 1996, p. 140.
136. Ibid.
137. Portree, "Heritage," p. 121.
138. van den Berg, "MirNews" 289, Feb. 16, 1996.
139. ESA Press Releases 08-96 and 09-96.
140. Kidger, "Science Tasks....," p. 141.
141. Kidger, "Crew Change at Mir," *Spaceflight*, v. 38, May 1996, p. 152.
142. Ibid.
143. Ibid.
144. van den Berg, "MirNews" 292, Feb. 29, 1996.

145. Kidger, "Crew Change....," p. 153.
146. Huset, "Mirwatch." April 1996.
147. van den Berg, "MirNews" 293 and 294, March 13 and 15, 1996.
148. NASA PAO, STS-76 Mission Status Reports 1 and 2, March 22, 1996.
149. NASA PAO, STS-76 Mission Status Reports 2 and 3, March 22 & 23, 1996.
150. NASA PAO, STS-76 Mission Status Report 3, March 23, 1996.
151. NASA PAO, STS-76 Mission Status Report 4 March 24, 1996.
152. NASA PAO, STS-76 Press Kit, "Mir Rendezvous and Docking."
153. NASA PAO, STS-76 Mission Status Reports 4 and 5, March 24, 1996.
154. James R. Asker, "Mir Spacewalk Set for Atlantis Crew," Aviation Week & Space Technology, March 18, 1996, p. 61.
155. NASA PAO, STS-76 Mission Status Report 8 March 26, 1996.
156. NASA PAO, STS-76 Press Kit.
157. Ibid.
158. Ibid.
159. NASA PAO, STS-76 Mission Status Reports 8 and 9, March 26, 1996.
160. NASA PAO, STS-76 Press Kit.
161. Ibid.
162. NASA PAO, STS-76 Mission Status Report 10, March 27, 1996.
163. NASA PAO, STS-76 Mission Status Report 12 March 28, 1996.
164. Johnson Space Center, Space News Roundup, April 5, 1996, p. 4.
165. NASA PAO, STS-76 Mission Status Report 17, March 30, 1996.
166. Moscow Mission Control Center, Mir Status Reports 1,2 and 3, April 5, 12, and 19, 1996.
167. "Russians Delay Launch of Priroda Module," Aviation Week and Space Technology, Feb. 5, 1996, p. 64.
168. Joseph C. Anselmo, "Priroda, Mir Dock," Aviation Week & Space Technology, May 6, 1996, p. 63.
169. Mir Extension Assessment Team, p. 7-9.
170. Gary H. Kitmacher, "Integration of Systems on Mir Processes and Comparisons," presented at the 33rd Space Congress, [Location?] April 23-26, 1996.
171. "The Priroda Mission," (<http://www.ba.dlr.de/NE-WS/ws5/priroda.html>).
172. Anser CIAC, Moscow Office Report 183.
173. van den Berg, "MirNews" 300, April 26, 1996.
174. Ibid.
175. Moscow MCC, Mir Status Report 5, May 3, 1996) (Mir 21 Weekly Update from NASA Home Page, June 14, 1996.
176. Mission Control Center, Moscow, Mir Status Reports 6 and 7, May 10 and May 17, 1996.
177. "News breaks," Aviation Week and Space Technology, May 27, 1996, p. 16.
178. Moscow MCC, Mir Status Report 8, May 24, 1996.
179. van den Berg, "MirNews" 305, May 21, 1996.
180. Florida Today, "Space Today," May 25, 1996.
181. Moscow MCC, Mir Status Report 9, May 31, 1996.

182. Moscow MCC, Mir Status Report 10, June 7, 1996.
183. van den Berg, "MirNews" 309, June 7, 1996.
184. Moscow MCC, Mir Status Report [11] June 14, 1996.
185. van den Berg, "MirNews" 310, June 13, 1996.
186. Moscow MCC, Mir Status Reports [11], [12], and 13, June 14, 21, and 28, 1996.
187. Moscow MCC, Mir Weekly Update, Aug. 2, 1996.
188. Moscow MCC, Mir Status Report 19, Aug. 9, 1996.
189. Centre National d'Etudes Spatiales, Cassiopee press releases, Aug. 21-Sept. 17, 1996.
(www.cnes.fr/IO_Vol_habit/cas)

Index

A

air supply systems 10, 29, 39, 42, 47
ALICE II experiment 50
Alisa lidar 43
Andre-Deshays, Claudie 49, 50
androgynous peripheral assembly system
(APAS) 18, 20, 30
anniversaries
–Gagarin flight 11
–Mir launch, 10th anniversary 36
–Mir launch, 9th anniversary 8
Anticipatory Postural Activity (POSA)
experiment 48
APAS; APDA; APDS.
See androgynous peripheral assembly
system
Apollo-Soyuz Test Project 18
art contest 33
Astra-2 14
Astro-2 52
astrophysics experiments 3, 8, 27
Atlantis (Space Shuttle).
See STS-71, STS-74, and STS-76
Atlas-03 51
automatic docking systems. *See* Kurs
Avdeyev, Sergey 26, 28

B

backpacks 40
Baker, Ellen S. 20
batteries, electric 39, 41, 42, 44, 45
Biokin air scrubber 29
biomedical samples 17, 22, 35
Biorack experiments 38, 39
Biotechnology System Facility 47
Boutrous-Ghali, Boutrous 32
Budarin, Nikolai 20-23, 26

C

CADMOS 49
Cameron, Kenneth D. 29, 30, 32
Canadian participation at Mir 26, 30, 32
Candle Flame in Microgravity (CFM) 48
cardiovascular system 10, 17, 23, 27, 49
Cassiopee mission 48-50
CASTOR 50
Centre National d'Etudes Spatiales.
See CNES
Chernomyrdin, Viktor 10, 32
Chibis suit 10, 17, 37
Chilton, Kevin 38, 41

Clifford, Rich 38, 40
CNES 49
COGNILAB 50
Collins, Eileen M. 5, 6
comet Giacobini Zinner 28
comet Hyakutake 39
computer malfunction 23
cooling systems 28, 35
See also air supply systems
cooperative solar array
See Mir cooperative Solar Array
countermeasures exercises 17, 23
crops 37, 48, 50

D

Dezhurov, Vladimir 9, 12, 13
Discovery (Space Shuttle).
See STS-63
Docking Module 1, 32, 38
–description 30
–EVA on exterior 40
–on-orbit assembly 19
–illustrations 31, 34
docking systems. *See* androgynous peripheral
assembly system (APAS)
dockings with Mir *See also* redockings
–Atlantis 20, 32, 39
–Priroda 44
–Progress-M modules 8, 11, 25, 27,
35, 45, 48, 50
–Spektr 16
–Soyuz-TM modules 9, 26, 37, 49
Dunbar, Bonnie J. 20
Dutch participation at Mir 29, 39
DYNALAB 50

E

eggs, quail 11
Earth observations 4, 14, 37, 41
Earth science studies 42, 46
Endavour (Space Shuttle) 9
Enhanced Dynamic Load Sensors 48
ESA. *See* European Space Agency
ESEF. *See* European Space Exposure Facility
Euromir 94 3
Euromir 95 25, 26, 32, 53
–experiments 27, 33, 35
–mission extension 28
European Space Agency 1, 3, 26, 28, 51, 54
European Space Exposure Facility 15, 27,
28, 36

Extravehicular activity (EVA)
 –ESA (at Mir) 28
 –Mir 18 12, 13, 16, 17
 –Mir 19 23-25
 –Mir 20 28, 34, 35
 –Mir 21 37, 40, 46
 –on Docking Module exterior 40
 –on Priroda exterior 46
 –restraints for 40, 42, 46
 –solar array work. *See* solar arrays
 –STS-63 7, 51
 –U.S. (at Mir) 37, 38, 40

F

Faza spectrometer 14
 Feniks spectrometer 14
 FERTILE 50
 Feustel-Buechl, Jorg 26
 fluid dynamics experiment 50
 fly-arounds 6, 41
 Foale, Michael 5, 7
 foot restraints, EVA 40
 Forced Flow Flamespread test 48
 freezers 17
 French participation at Mir 3, 14, 39, 43,
 49-50
 French Space Agency (CNES) 49
 fuels tests 48
 Fundamental Biology Greenhouse.
See greenhouse

G

Gallar furnace 4, 25
 German participation at Mir 11, 26, 27, 30,
 39, 43, 46
 germetik sealant 25
 GFZ-1 satellite 11
 Gibson, Robert L. 19, 20
 Gidzenko, Yuriy 26, 28
 glovebox stowage 39
 Godwin, Linda 38, 40, 41
 Goldin, Daniel 19, 32
 Grab Sample Container (GSC) 47
 greenhouse 47, 48
 Grif equipment 14
 gyrodynes 11, 25, 33, 39, 48

H

Hadfield, Chris A. 29, 30
 Halsell, James D. 29, 30
 handrails 40, 46

Harbaugh, Greg 20
 Harris, Bernard A, Jr. 5, 7
 hooks, tether 40
 Humoral Immunity Experiment 47

I

Icon key 2
 IKAR (radiometers) 43
 International Space Station
 –EVA equipment tests 40
 –Phase 1 1, 5, 31, 32
 –Risk Mitigation Experiments 33
 –solar array materials 31
 ISTOK-1 43

K

Kaleri, Alexander 49
 Kobe (Japan) earthquake 4
 Komza interstellar gas detector 14, 46
 Kondakova, Yelena 3
 Konus (docking cone) 13, 16, 34
 Koptev, Yuri 9, 19
 Korzun, Valery 49
 Kristall
 –antenna work 36
 –batteries 12, 17
 –relocations 13, 17, 24
 Kurs docking systems
 –control of dockings 8, 11, 16, 25, 45
 –on Priroda 42, 44
 –on Spektr 14
 –test 4

L

laser docking aid, handheld 32
 leaks
 –coolant loop 28, 35, 41, 45
 –gas (on Space Shuttle) 4, 47
 –hydraulic (on Atlantis) 38
 –water 37
 life sciences research 27, 41
 Liquid Diffusion-II payload 46
 Lira equipment 14
 lithium hydroxide 28, 32
 Littles, Wayne 9
 Luch-1 satellite 4
 Lucid, Shannon 37-39, 46, 47
 Lyappa arm
 –on Kristall 13, 17, 24
 –on Priroda 42, 44
 –on Spektr 14, 16

M

maintenance work aboard Mir 4, 10, 11, 25, 28, 33, 47, 48
Maksat experiments 4
Manakov, Gennady 49
Manley, John 32
Maria equipment 4, 35
Mars missions 10, 48
materials science 27, 33, 35, 39, 46, 48
McArthur, William S., Jr. 29, 30
medical studies 3, 5, 7, 15, 22, 23, 33, 37, 43, 47, 50
Merbold, Ulf 3
metabolic experiments 10
microgravity effects. *See* weightlessness
Microgravity Isolation Mount (MIM) 47
Midcourse Space Experiments 54
Mir 17 3-8, 51
Mir 18 9-20, 52
Mir 19 22-25, 53
Mir 20 26-36, 53
Mir 21 37-50, 54
Mir 22 49
Mir Cooperative Solar Array 31, 38, 46
Mir Environmental Effects Payload 40
Mir Infrared Atmospheric Spectrometer 14, 24, 25
Mir interface-to-payload systems 41, 45
Mir Principal Expeditions. *See* Mir 17, Mir 18, Mir 19, Mir 20, Mir 21, Mir 22
Mir Sample Return Experiment 46
Modular Optoelectronic Multispectral Scanner 43, 46
MOS spectrometers 43
MSU scanners 43

N-O

Nausica apparatus 3
ODS. *See* Orbiter Docking System (OLiPSE). *See* Optizon furnace
Onufrienko, Yuri 37
optical instruments 43
Optizon furnace 39, 47
Optovert equipment 33
orbital environment studies 3, 10, 14, 15, 26, 33, 40
Orbital Acceleration Research Experiment 54
Orbiter Docking System 18, 29, 39
Orbiter space vision system 29, 31
Orlan-DMA suit 12, 24, 34
Oswald, Steve 9
oxygen system 29, 47
See also air supply systems

OZONE-M 43

P

Particle Impact Experiment 46
passive microwave equipment 43
Photogrammetric Appendage Structural Dynamics Experiment 32
PHYSIOLAB 49
Pion optical complex 14
Polyakov, Valeri 3, 4, 7, 10
port orientation diagram 16
power supply problems 12, 47
See also batteries, electric
Precourt, Charles J. 20
Priroda [module] 1, 37, 55
–batteries, electric 41-45
–description 42
–EVA on 46
–illustrations 43, 45
–launch 41
–preparation of Mir for 34
–relocation 44
Priroda-5 Earth imaging system 14
Progress-M 25 3, 8, 51
Progress-M 26 7-9, 52
Progress-M 27 11, 13, 52
Progress-M 28 25, 53
Progress-M 29 27, 35, 54
Progress-M 30 35, 36, 54
Progress-M 31 44, 45, 48, 55
Progress-M 32 48-50, 55

Q-R

Queen's University Experiment in Liquid Diffusion (QUELD) 48
Radiation monitoring 3, 10, 12, 14, 15, 27, 33, 41, 48
Rapana girder 46
R-bar approach 19, 32, 38
records
–humans in space 9
–humans on Mir 20
–human spaceflight duration 3, 10, 17, 37, 47
redockings with Mir 4, 13, 16, 17, 22, 24, 44, 50
refueling of base block 25
Reiter, Thomas 26, 27
Remote Manipulator System (RMS) 29
rendezvous
–STS-63 with Mir 6
–STS-71 techniques 19
Rodnik 22

Roentgen Observatory 4
Ross, Jerry L. 29, 30
Russian Institute for Biomedical Problems 5, 33
Ryabina-4P cosmic ray sensor 14

S

SAFER (backpack) 40
sample return experiment 46
Searfoss, Rick 38
Sega, Ron 38, 40
shower dismantled 11
Shuttle-Mir science program 20
simplified aid for EVA rescue 40
Skif 37
solar arrays
–EVA work on 11, 12, 17, 23, 38
–Mir Cooperative Solar Array 30, 31, 38, 46
–on Kristall 4, 12, 13
–on Kvant 12, 46
–on Kvant 2 23
–on Spektr 14, 17, 22, 23
–structural dynamics of 32
Solid Sorbent Air Sampler 47, 48
Solovyev, Anatoly 20-23, 26
Solovyev, Vladimir A. 6
Soyuz-TM 20 3, 4, 52
Soyuz-TM 21 9, 22, 26, 52
Soyuz-TM 22 26, 37, 53
Soyuz-TM 23 28, 36, 50, 54
Soyuz-TM 24 50, 55
Space Acceleration Measurement System 41
Space Shuttle. *See* STS- missions
spacecraft environment (onboard) 10, 27, 33, 47, 48
Spacehab 5, 39, 55
Spacelab 20, 22, 23, 52, 55
Spartan-201 54
Spartan-204 5, 7, 51
Spartan-207/IAE 55
Spektr 1, 9, 52
–description 14
–docking 16
–illustrations 15, 24
–launch 12
–launch delay 11
–relocation 16
–preparation of Mir for 12
–solar arrays 17, 22, 23

SPK maneuvering unit 35
Strekalov, Gennadiy 9, 11-13
Strela boom 12, 23, 25, 28, 35, 38
–second Strela 38, 46
STS-63 3-6, 51
STS-66 51
STS-67 9, 52
STS-69 54
STS-70 53
STS-71 17, 19-22, 53
STS-73 54
STS-74 24, 29, 30, 32, 33, 54
STS-75 54
STS-76 38-41, 55
STS-77 55
STS-78 55
STS-74 Solar Array Package 31
Svet facility 47
synthetic aperture radar (SAR) 43

T

Taurus system 15
television commercial filming 46
tether hooks 40
Tethered Satellite System 54
Thagard, Norman 7, 9, 12, 17, 20
Tissue Equivalent Proportional Counter 48
Titov, Vladimir 4, 5
TITUS furnace 27, 35
Tracking and Data Relay Satellite 53
Travers radar antenna 42, 46
TREK detector 12, 24
TREILLIS 50

U

Uragan 9
Uran 26
Usachev, Yuri 37

V-W

Viktorenko, Alexandr 3, 6
Vinogradov, Pavel 49
Vityaz 3
Volna-2 35
Voss, Janice E 5
Wake Shield Facility 54
Wetherbee, James D. 5, 6
weightlessness effects 9, 23, 26, 27, 33, 35

REPORT DOCUMENTATION PAGE			Form Approved OMB No. 0704-0188	
Public reporting burden for this collection of information is estimated to average 1 hour per response, including the time for reviewing instructions, searching existing data sources, gathering and maintaining the data needed, and completing and reviewing the collection of information. Send comments regarding this burden estimate or any other aspect of this collection of information, including suggestions for reducing this burden, to Washington Headquarters Services, Directorate for Information Operations and Reports, 1215 Jefferson Davis Highway, Suite 1204, Arlington, VA 22202-4302, and to the Office of Management and Budget, Paperwork Reduction Project (0704-0188), Washington, DC 20503.				
1. AGENCY USE ONLY (Leave Blank)	2. REPORT DATE December 1998	3. REPORT TYPE AND DATES COVERED Technical Paper		
4. TITLE AND SUBTITLE Mir Mission Chronicle, November 1994 Through August 1996			5. FUNDING NUMBERS	
6. AUTHOR(S) Sue McDonald (NASA JSC)				
7. PERFORMING ORGANIZATION NAME(S) AND ADDRESS(ES) Lyndon B. Johnson Space Center Houston, Texas 77058-3696			8. PERFORMING ORGANIZATION REPORT NUMBERS S-844	
9. SPONSORING/MONITORING AGENCY NAME(S) AND ADDRESS(ES) National Aeronautics and Space Administration Washington, D.C. 20546-0001			10. SPONSORING/MONITORING AGENCY REPORT NUMBER NASA/TP-98-207890	
11. SUPPLEMENTARY NOTES				
12a. DISTRIBUTION/AVAILABILITY STATEMENT Unclassified/Unlimited Available from the NASA Center for AeroSpace Information (CASI) 7121 Standard Hanover, MD (301) 621-0390 Subject Category: 18			12b. DISTRIBUTION CODE	
13. ABSTRACT (Maximum 200 words) Dockings, module additions, configuration changes, crew changes, and major mission events are tracked for Mir missions 17 through 21 (November 1994 through August 1996). The international aspects of these missions are presented, comprising joint missions with ESA and NASA, including three U.S. Space Shuttle dockings. New Mir modules described are Spektr, the Docking Module, and Priroda.				
14. SUBJECT TERMS Mir Space Station, Spacecraft Docking, Space Stations, Spacecraft Configurations			15. NUMBER OF PAGES 66	16. PRICE CODE
17. SECURITY CLASSIFICATION OF REPORT Unclassified	18. SECURITY CLASSIFICATION OF THIS PAGE Unclassified	19. SECURITY CLASSIFICATION OF ABSTRACT Unclassified	20. LIMITATION OF ABSTRACT Unlimited	

